

Copa España Cadete Pamplona

Cad F -40

Competidores: 2

Competidores

Nº	Nombre	Club	1	2	1	2	1	2	Victs.	Pts.	Pos.
1	Rosi FERRER	Valencia							0	0	2
2	Justine POLIDANO	Francia							0	0	1

Combates

Comb.	Blanco			Azul	Resultado	Tiempo
1	Rosi FERRER	1	2	Justine POLIDANO		
2	Rosi FERRER	1	2	Justine POLIDANO		
3	Rosi FERRER	1	2	Justine POLIDANO		

Clasificación

Pos.	Nombre
1	Justine POLIDANO, Francia
2	Rosi FERRER, Valencia

Copa España Cadete Pamplona

Cad F -44

Competidores: 7

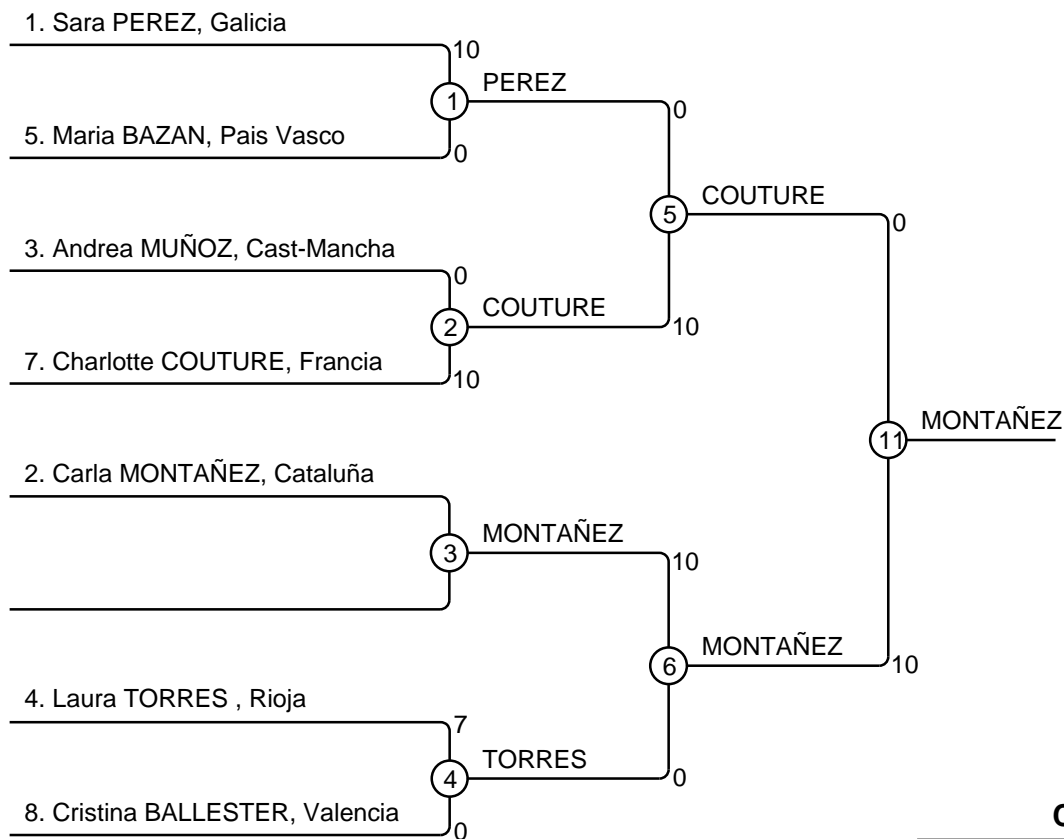

Clasificación

Pos.	Nombre
1	Carla MONTAÑEZ, Cataluña
2	Charlotte COUTURE, Francia
3	Laura TORRES, Rioja
3	Sara PEREZ, Galicia
5	Maria BAZAN, Pais Vasco
5	Cristina BALLESTER, Valencia
7	Andrea MUÑOZ, Cast-Mancha
7	

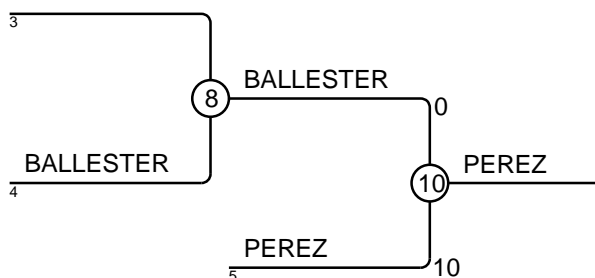
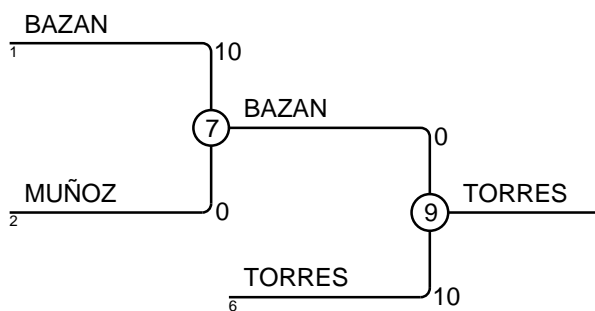

Copa España Cadete Pamplona

Cad F -48

Competidores: 17

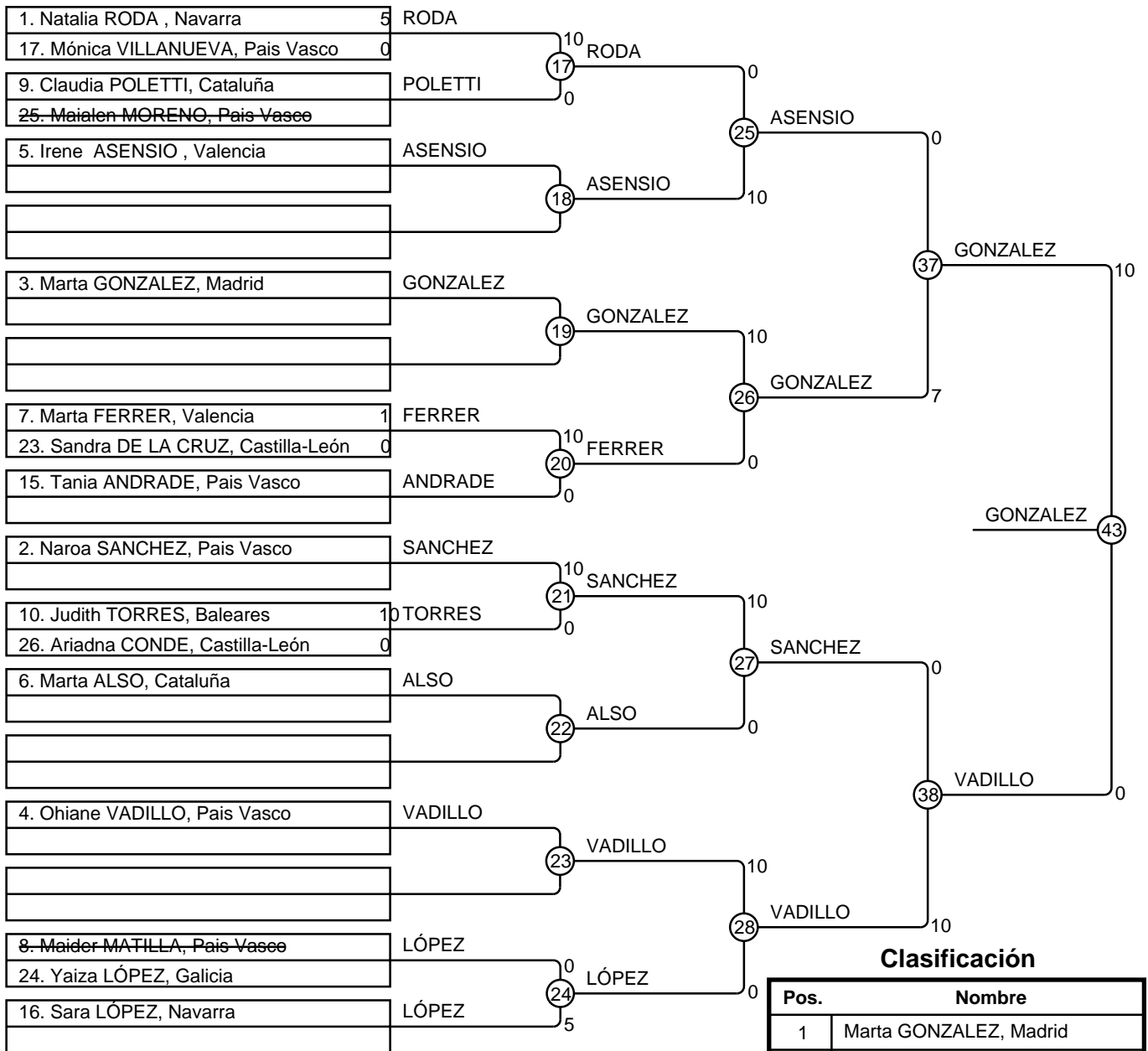

Clasificación

Pos.	Nombre
1	Marta GONZALEZ, Madrid
2	Ohiane VADILLO, Pais Vasco
3	Marta FERRER, Valencia
3	Irene ASENSIO, Valencia
5	Naroa SANCHEZ, Pais Vasco
5	Marta ALSO, Cataluña
7	Natalia RODA, Navarra
7	Sara LÓPEZ, Navarra

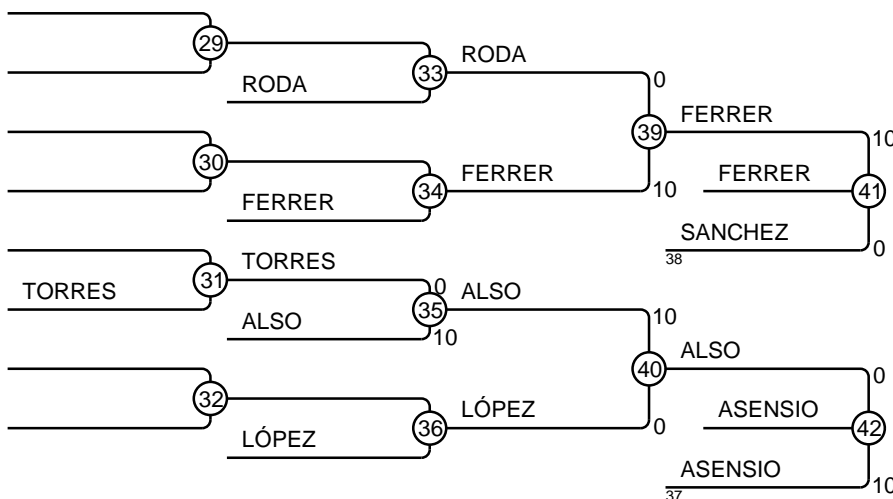

Copa España Cadete Pamplona

Cad F -52

Competidores: 33

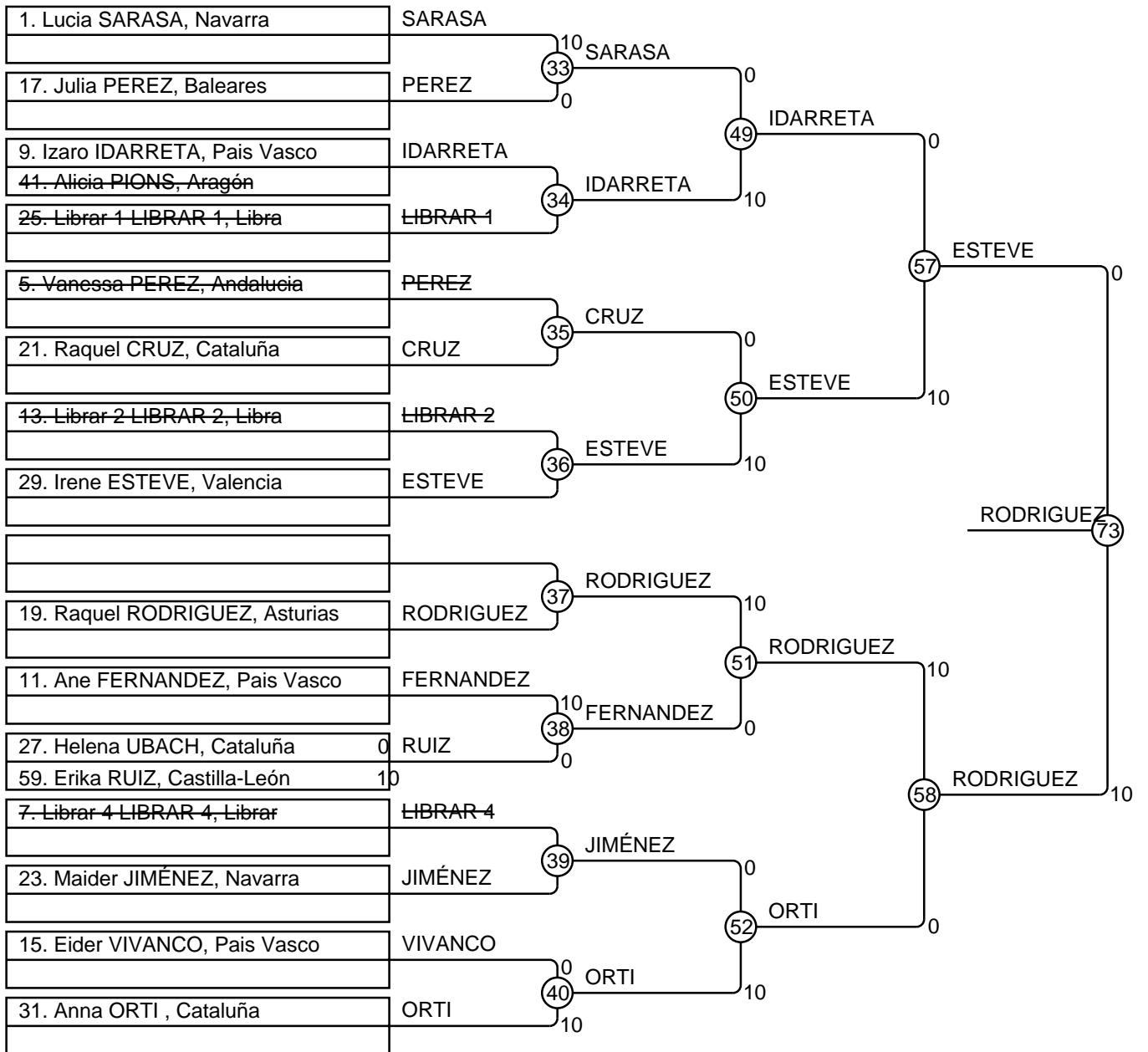

Copa España Cadete Pamplona

Cad F -52

Competidores: 33

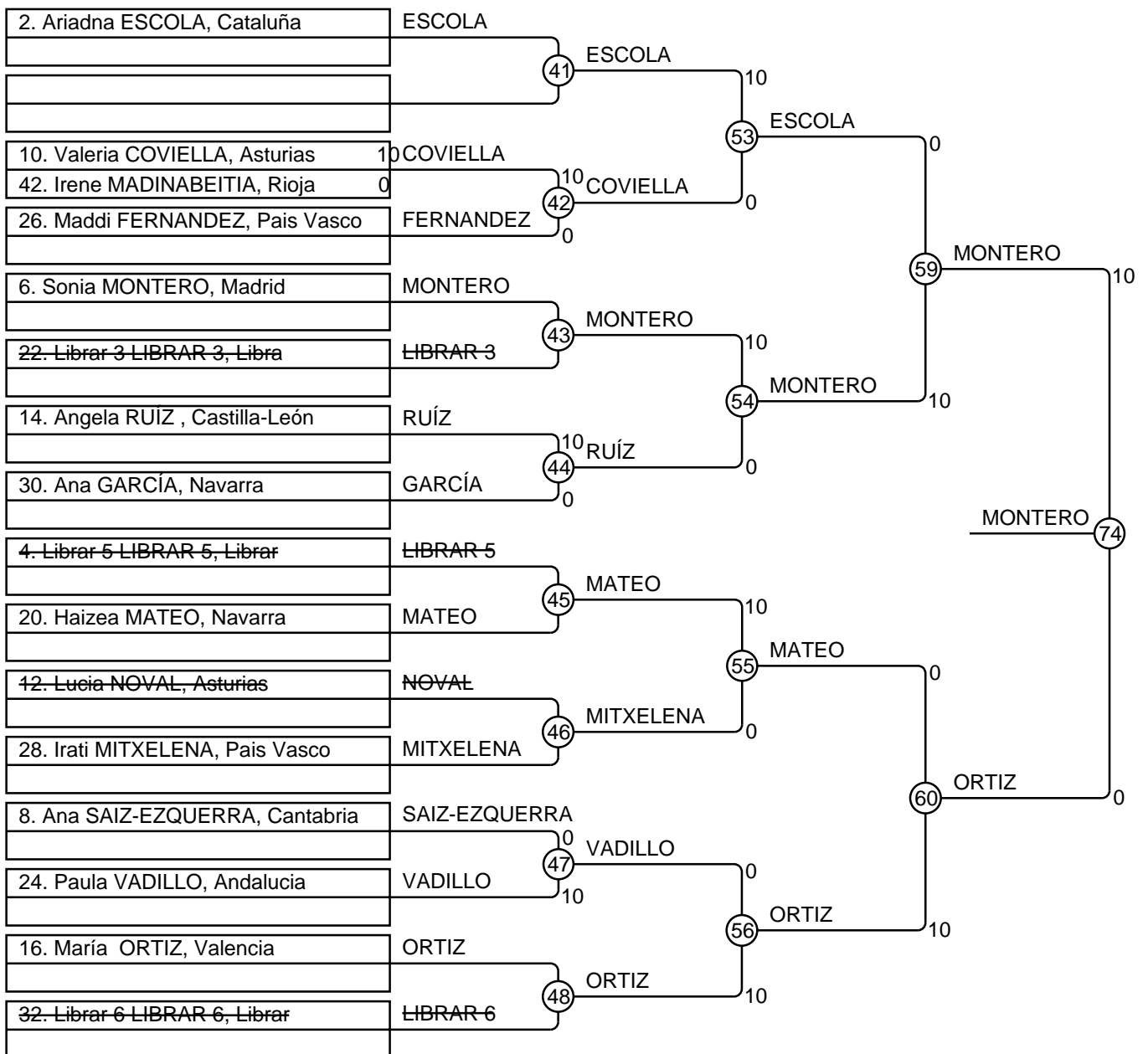

Copa España Cadete Pamplona

Cad F -57

Competidores: 33

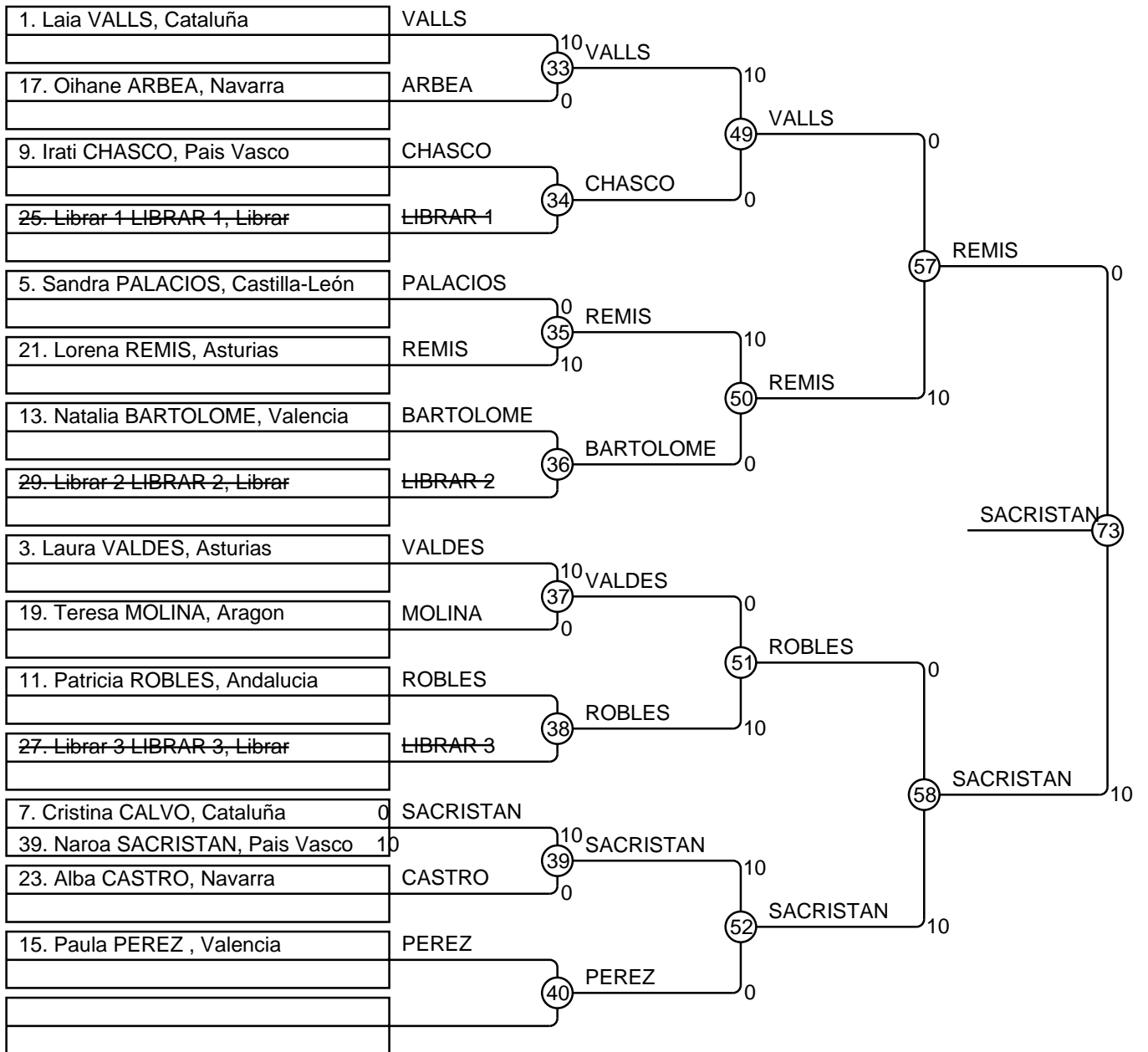

Copa España Cadete Pamplona

Cad F -57

Competidores: 33

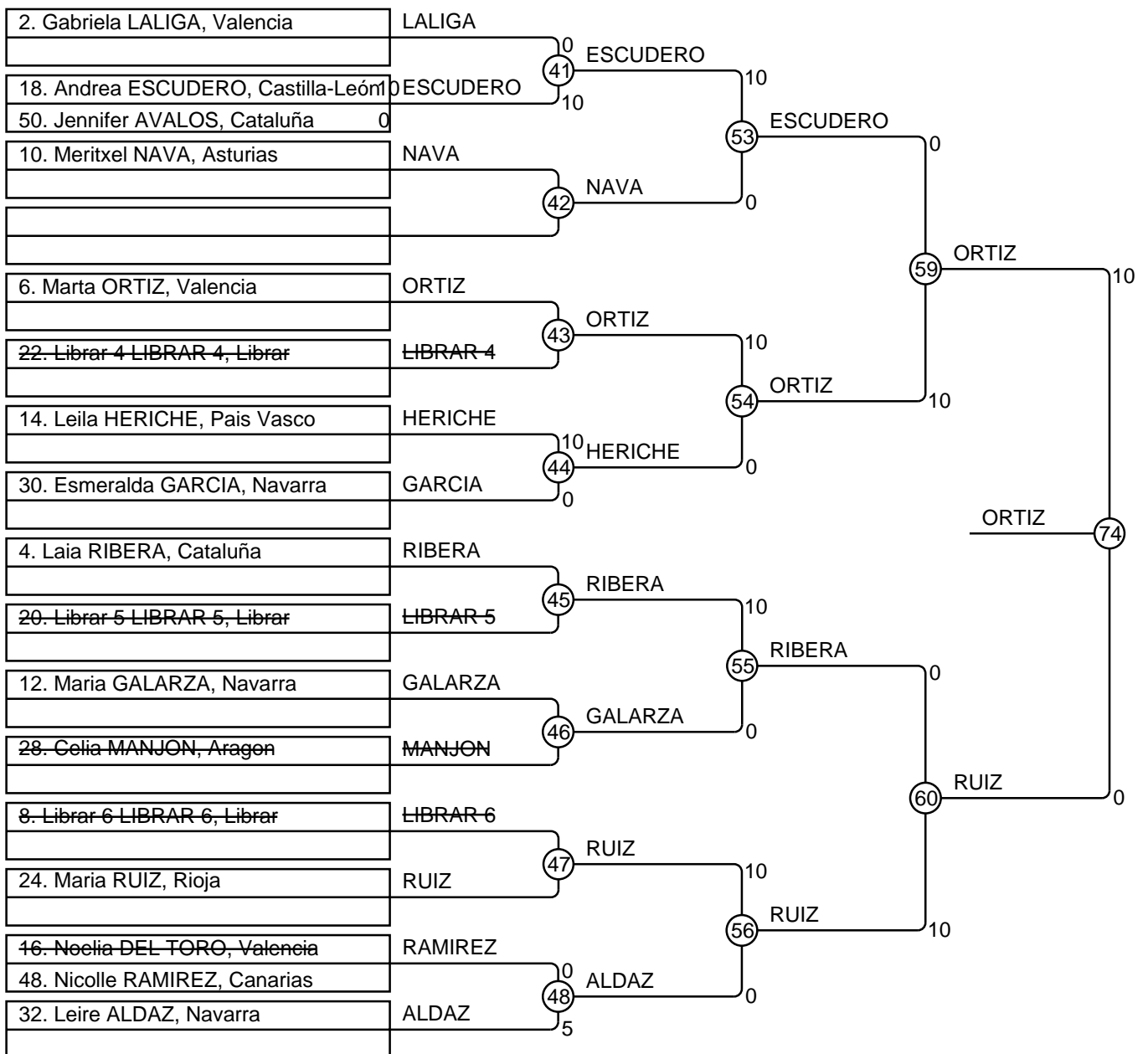

Copa España Cadete Pamplona

Cad F -57

Competidores: 33

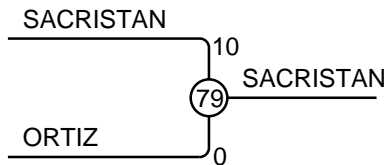
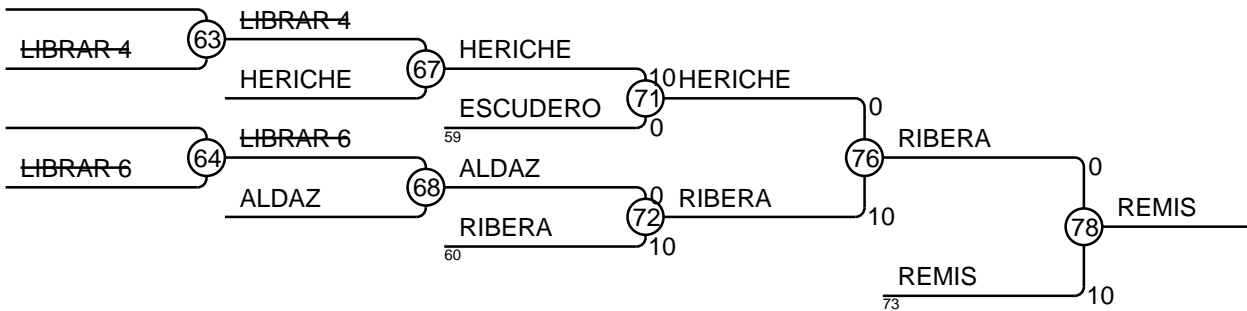
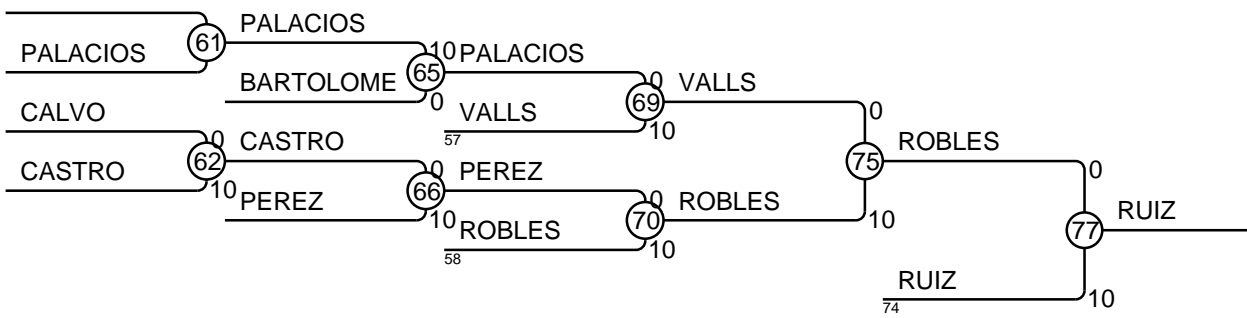

Clasificación

Pos.	Nombre
1	Naroa SACRISTAN, Pais Vasco
2	Marta ORTIZ, Valencia
3	Maria RUIZ, Rioja
3	Lorena REMIS, Asturias
5	Patricia ROBLES, Andalucia
5	Laia RIBERA, Cataluña
7	Laia VALLS, Cataluña
7	Leila HERICHE, Pais Vasco

Copa España Cadete Pamplona

Cad F -63

Competidores: 33

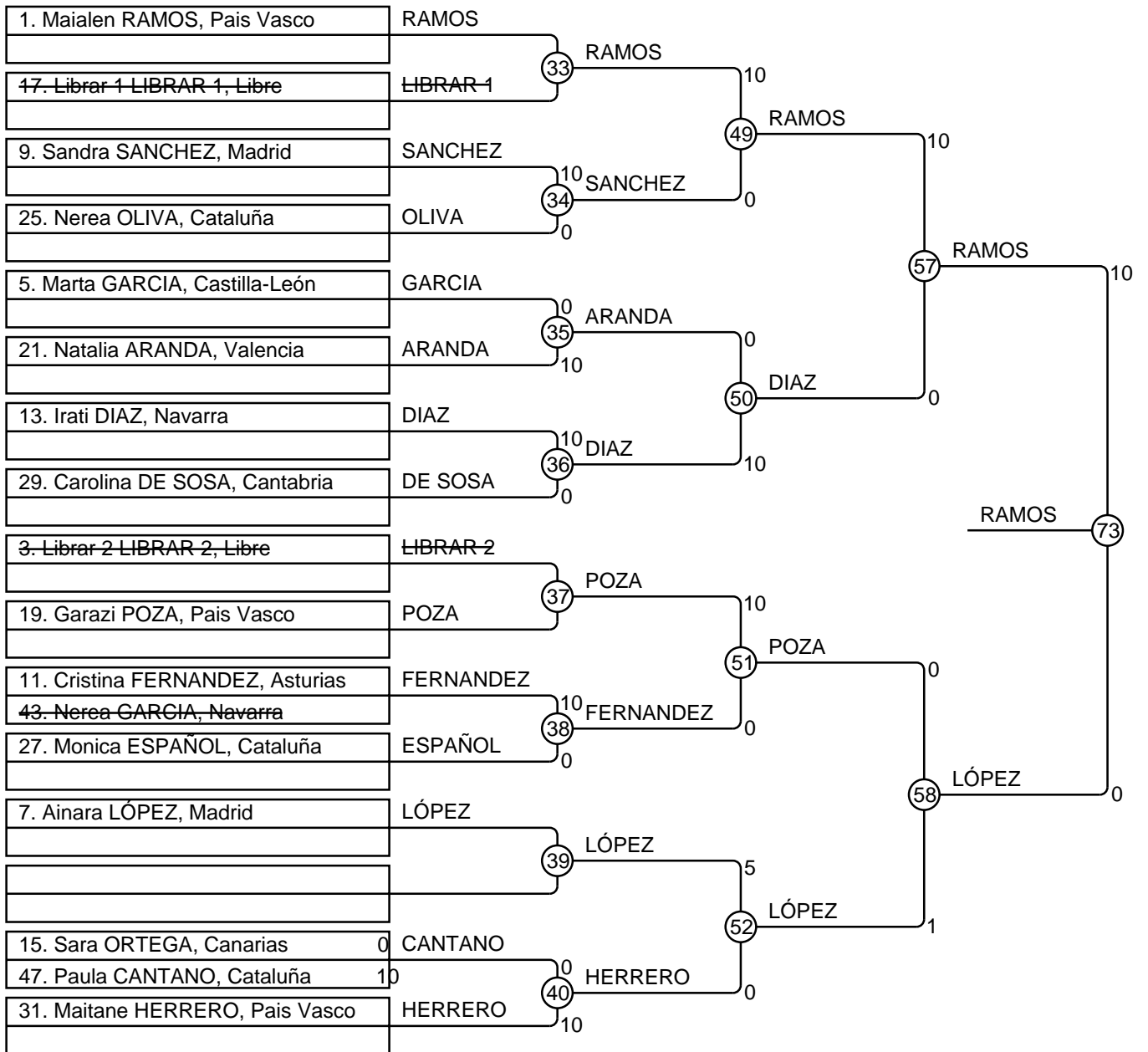

Copa España Cadete Pamplona

Cad F -63

Competidores: 33

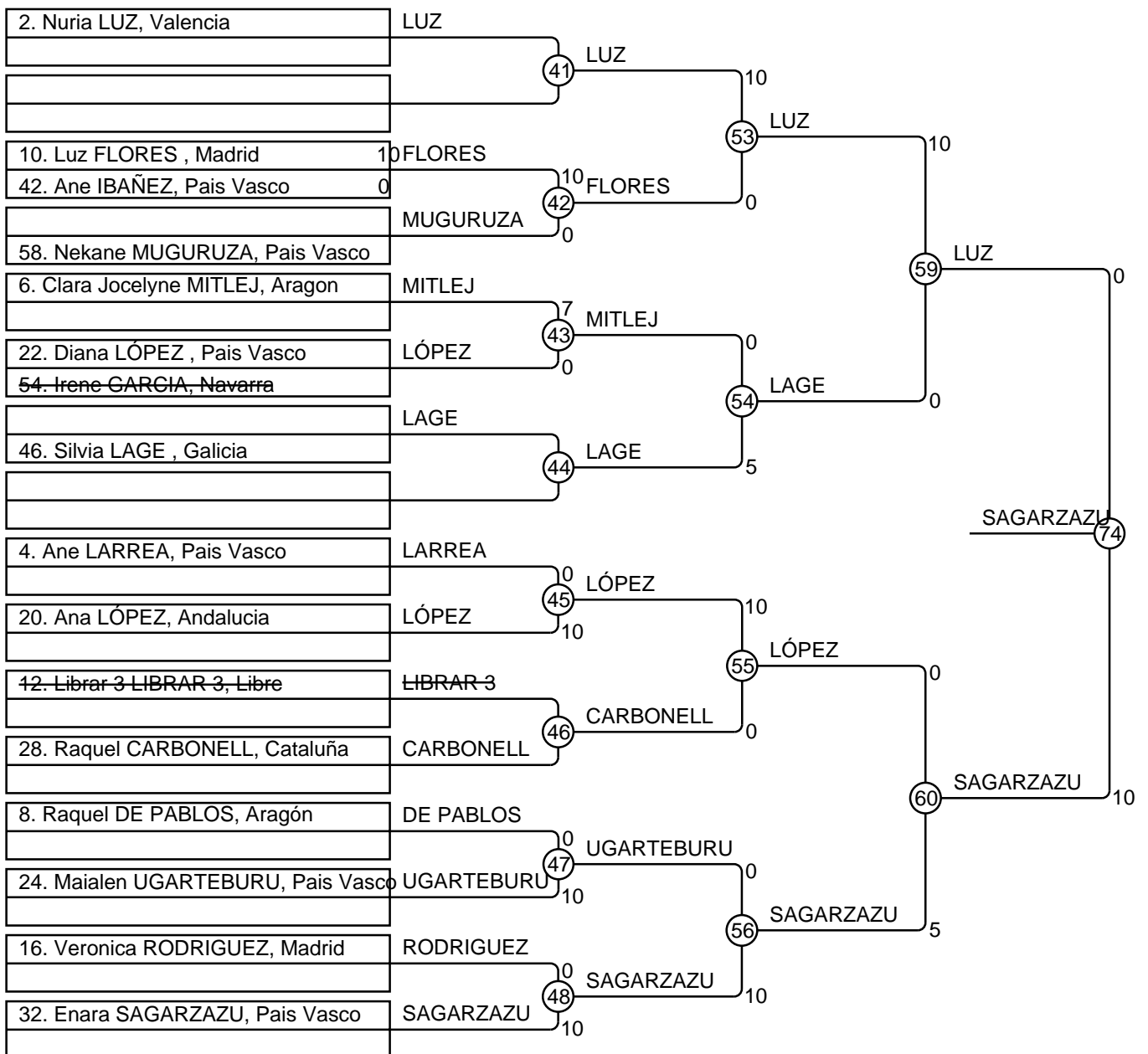

Copa España Cadete Pamplona

Cad F -63

Competidores: 33

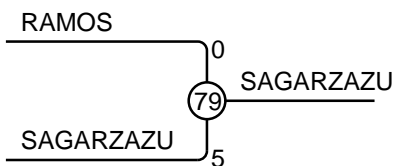
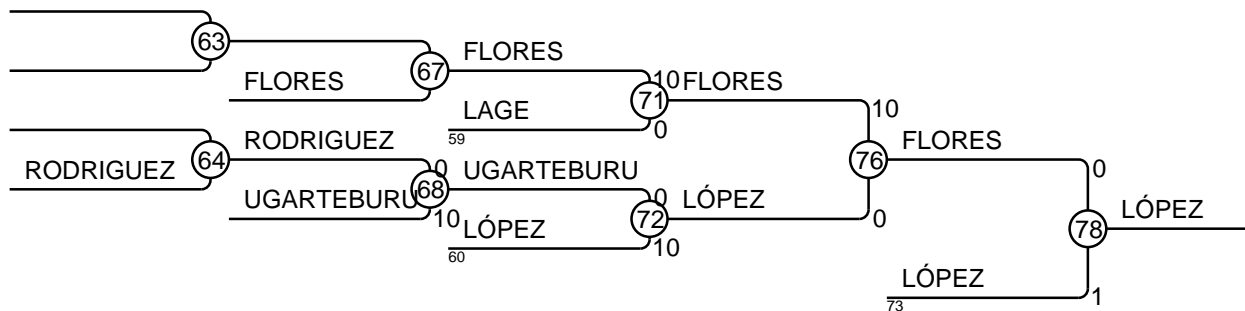
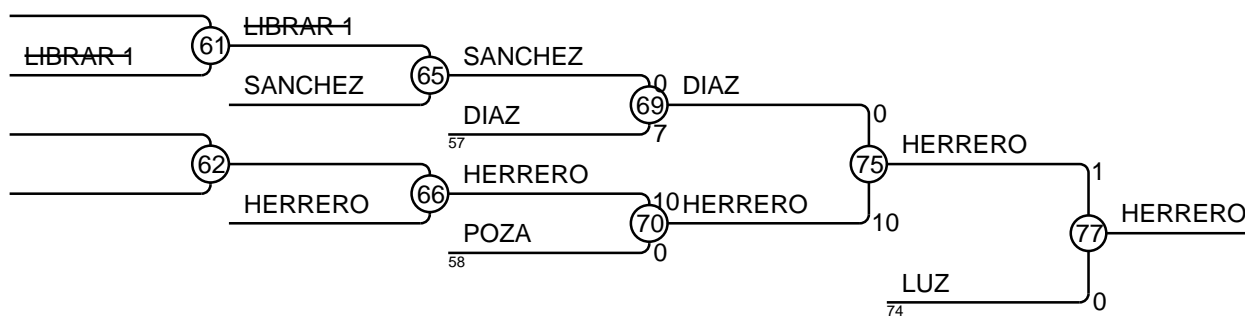

Clasificación

Pos.	Nombre
1	Enara SAGARZAZU, Pais Vasco
2	Maialen RAMOS, Pais Vasco
3	Maitane HERRERO, Pais Vasco
3	Ainara LÓPEZ, Madrid
5	Nuria LUZ, Valencia
5	Luz FLORES , Madrid
7	Irati DIAZ, Navarra
7	Ana LÓPEZ, Andalucia

Copa España Cadete Pamplona

Cad F -70

Competidores: 8

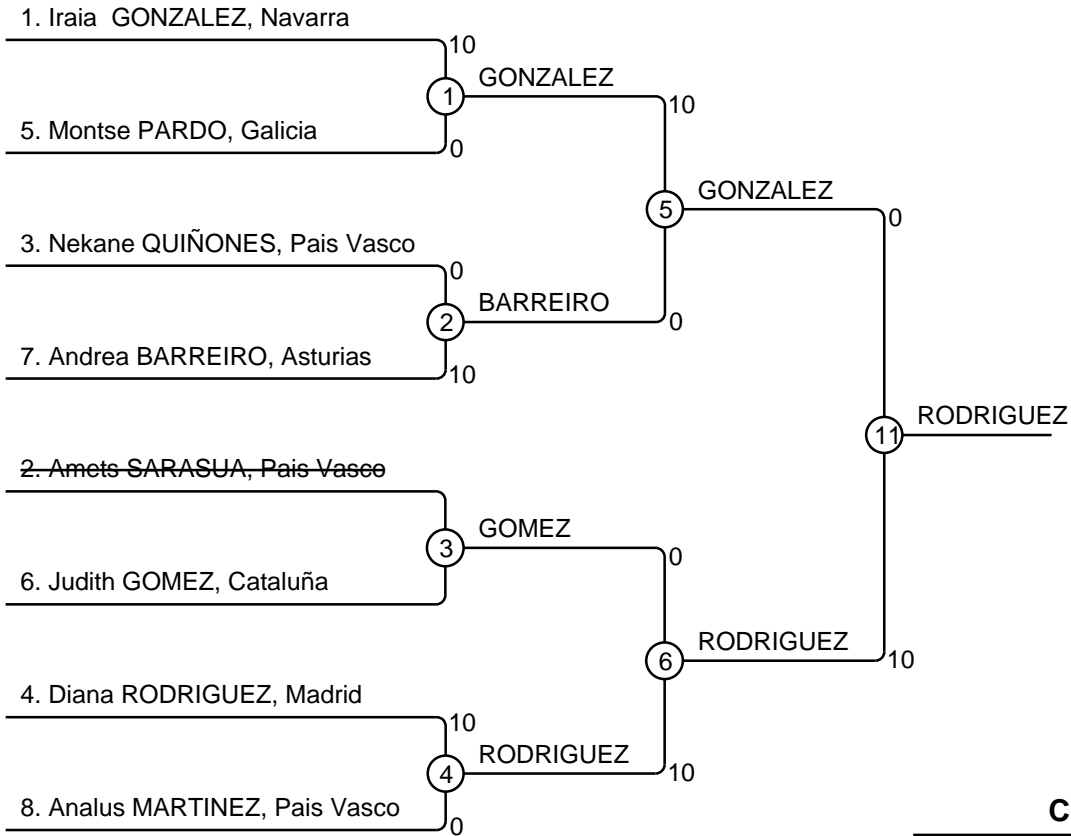

Clasificación

Pos.	Nombre
1	Diana RODRIGUEZ, Madrid
2	Iraia GONZALEZ, Navarra
3	Nekane QUIÑONES, Pais Vasco
3	Andrea BARREIRO, Asturias
5	Judith GOMEZ, Cataluña
5	Analus MARTINEZ, Pais Vasco
7	Montse PARDO, Galicia
7	

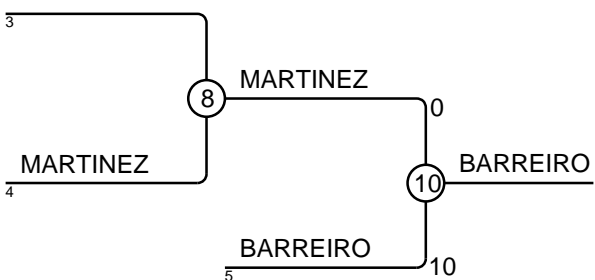
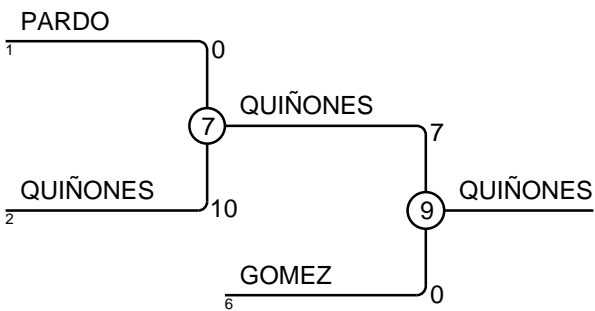

Copa España Cadete Pamplona

Cad F +70

Competidores: 10

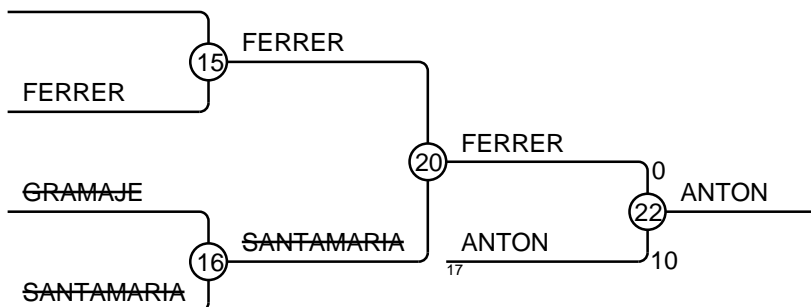
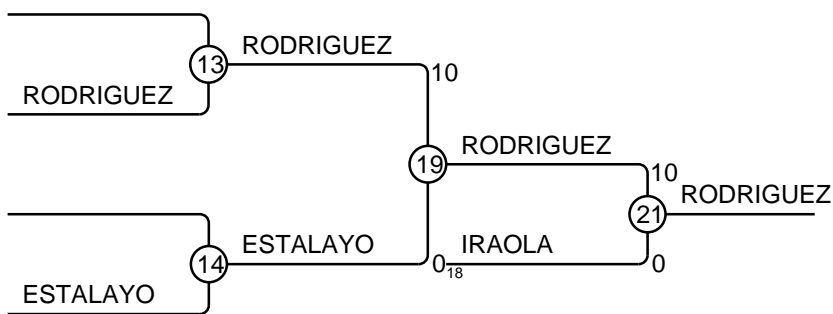
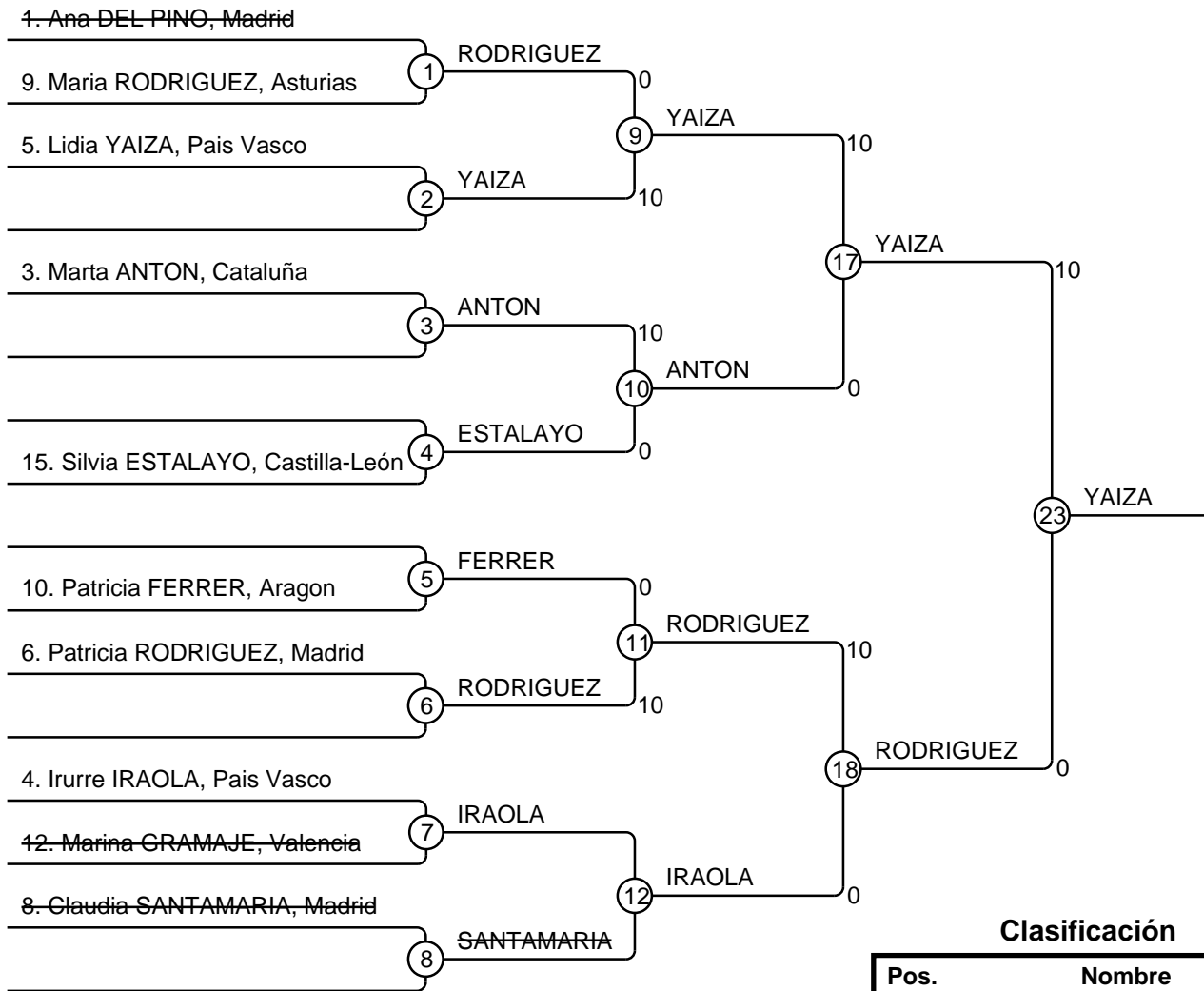

Clasificación

Pos.	Nombre
1	Lidia YAIZA, Pais Vasco
2	Patricia RODRIGUEZ, Madrid
3	Maria RODRIGUEZ, Asturias
3	Marta ANTON, Cataluña
5	Iurre IRAOLA, Pais Vasco
5	Patricia FERRER, Aragon
7	Silvia ESTALAYO, Castilla-León
7	

Copa España Cadete Pamplona

Cad M -50

Competidores: 33

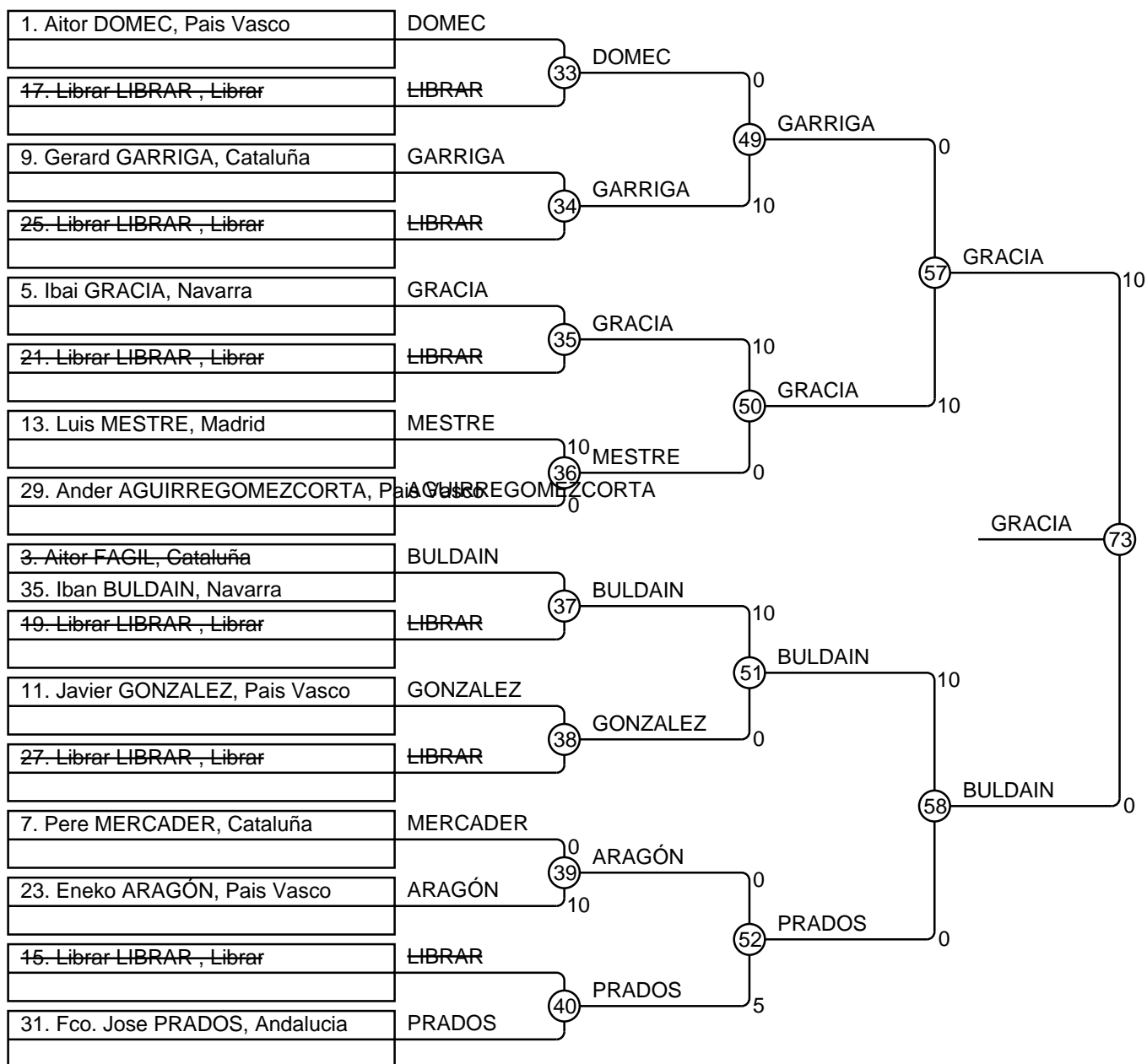

Copa España Cadete Pamplona

Cad M -50

Competidores: 33

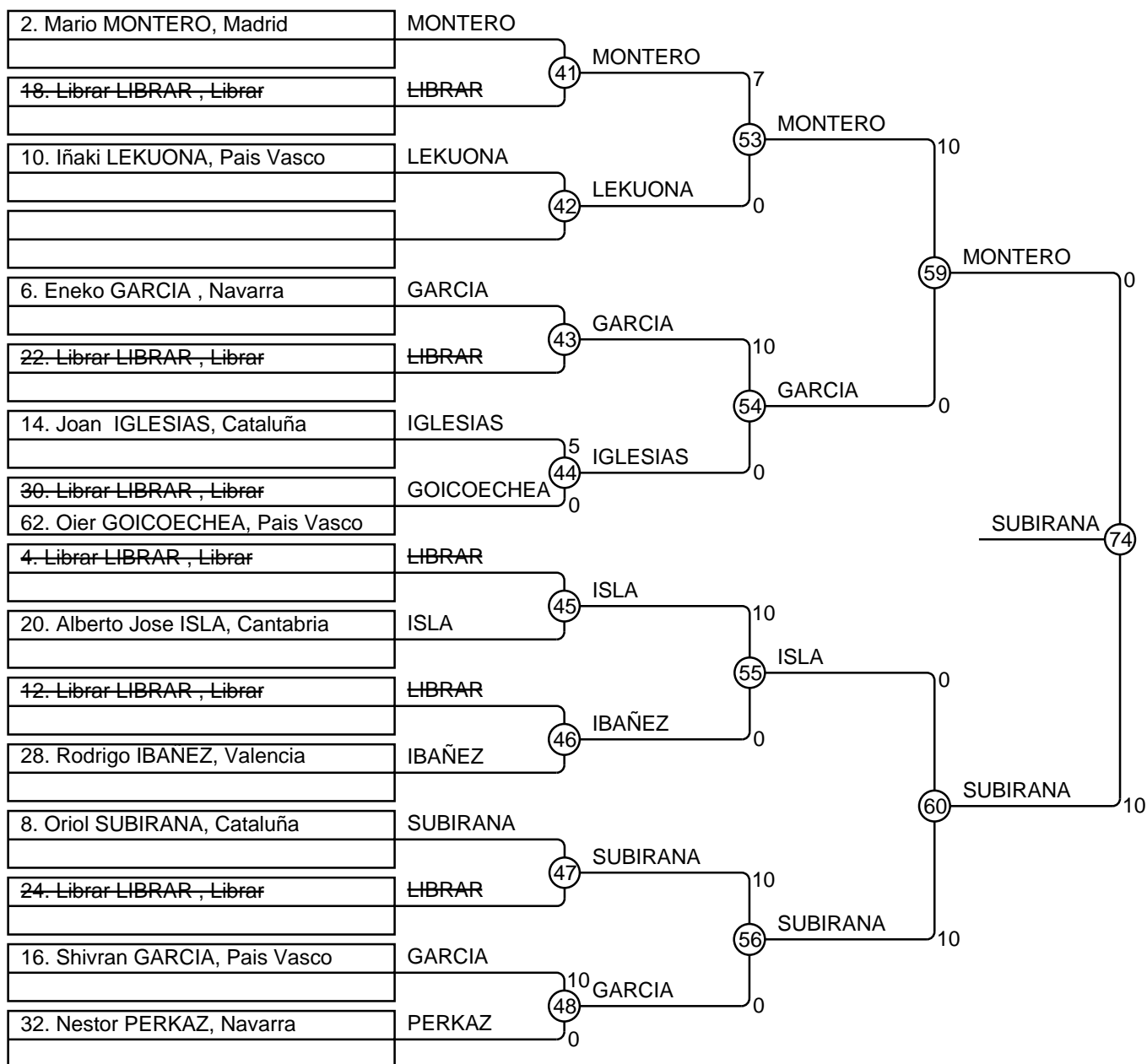

Copa España Cadete Pamplona

Cad M -50

Competidores: 33

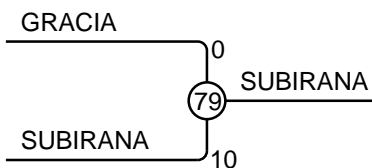
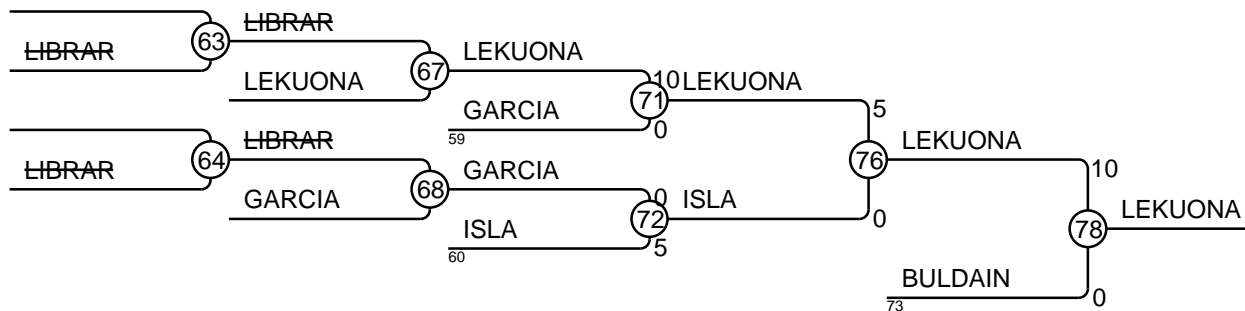
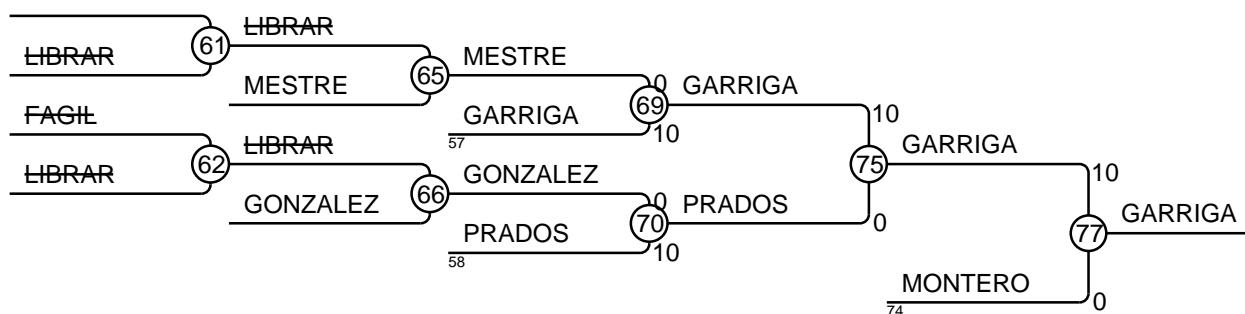

Clasificación

Pos.	Nombre
1	Oriol SUBIRANA, Cataluña
2	Ibai GRACIA, Navarra
3	Gerard GARRIGA, Cataluña
3	Iñaki LEKUONA, Pais Vasco
5	Mario MONTERO, Madrid
5	Iban BULDAIN, Navarra
7	Fco. Jose PRADOS, Andalucia
7	Alberto Jose ISLA, Cantabria

Copa España Cadete Pamplona

Cad M -55

Competidores: 33

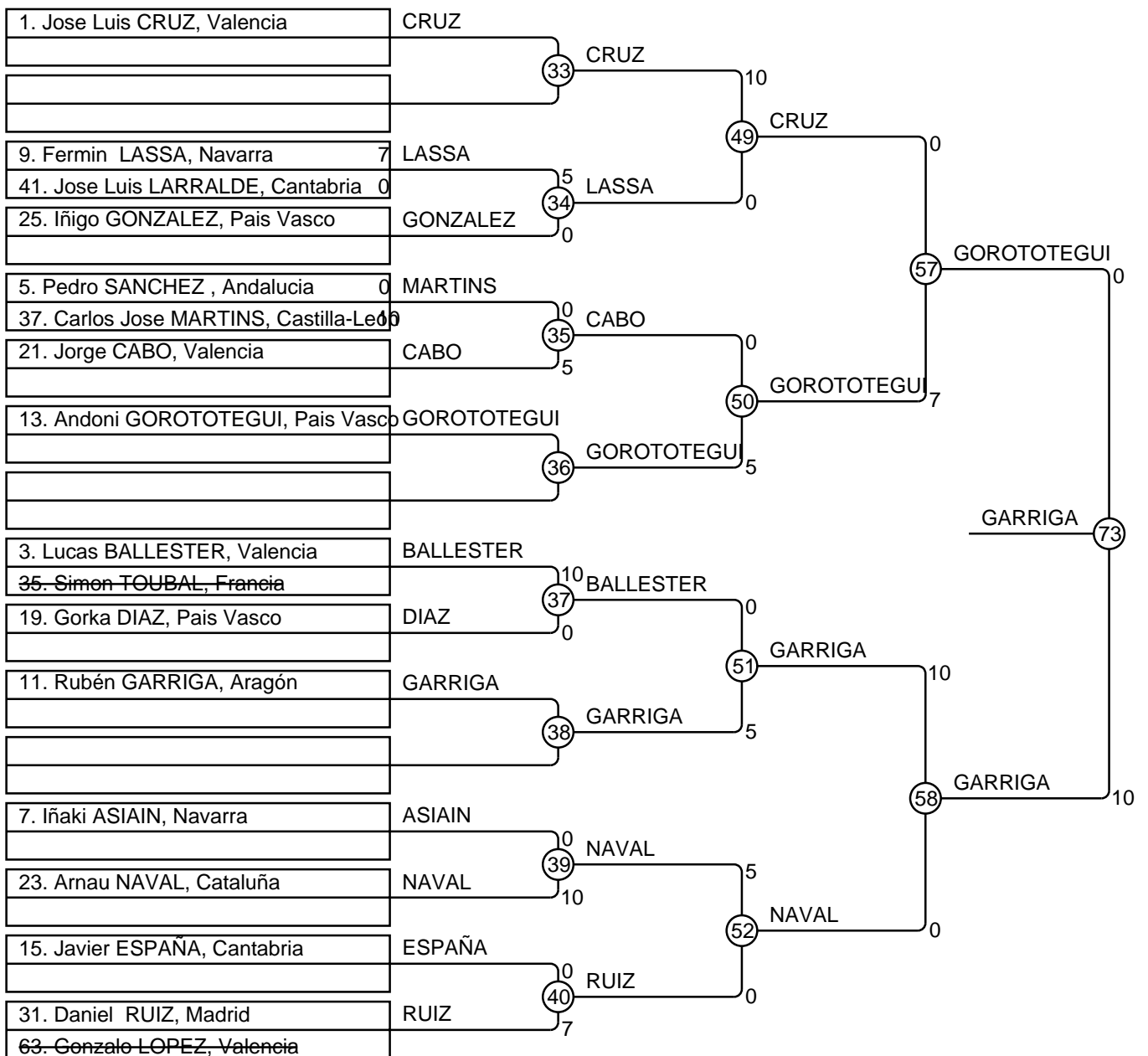

Copa España Cadete Pamplona

Cad M -55

Competidores: 33

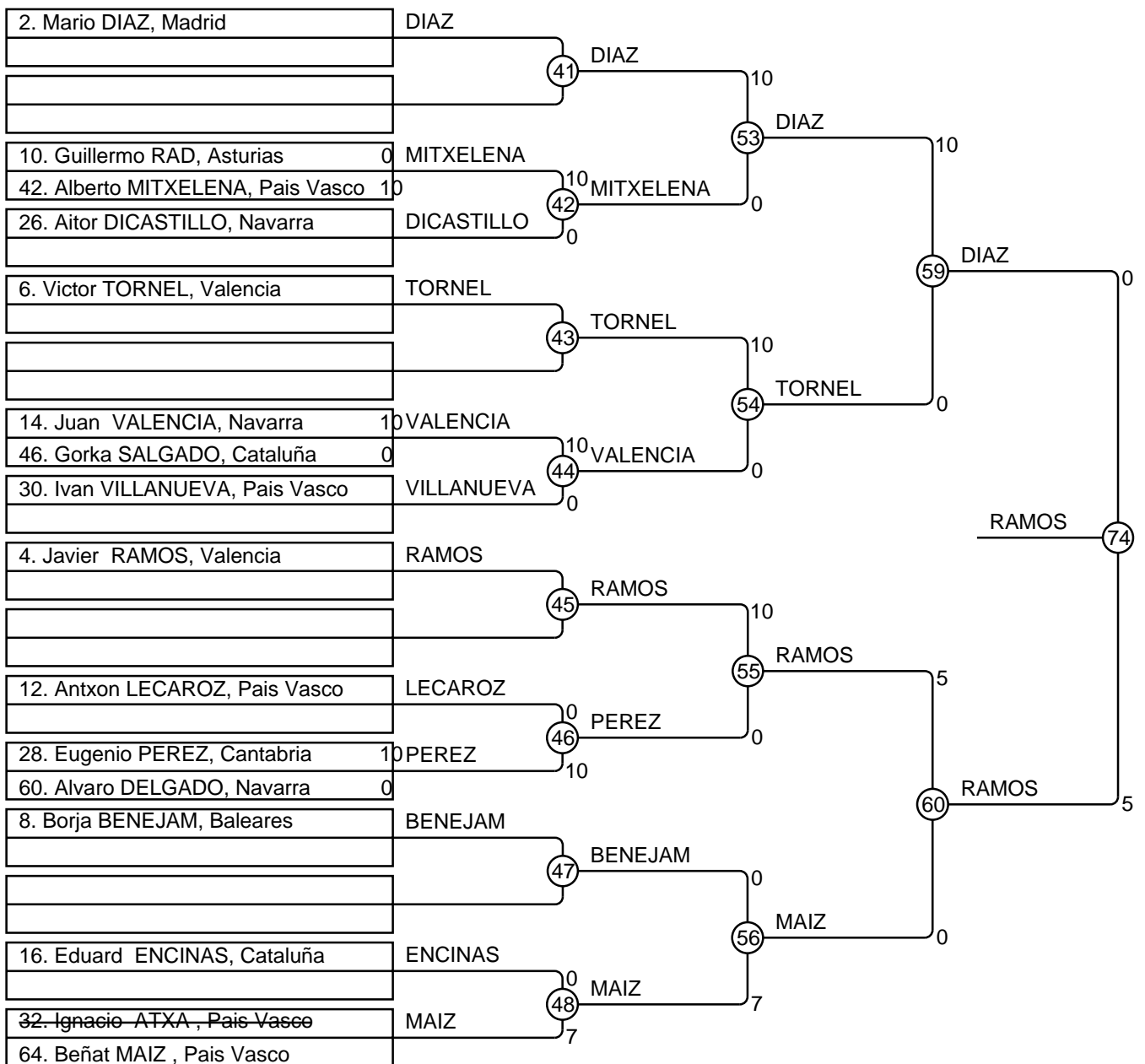

Copa España Cadete Pamplona

Cad M -55

Competidores: 33

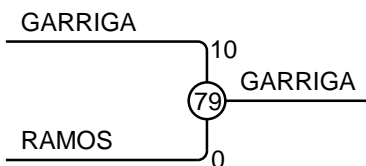
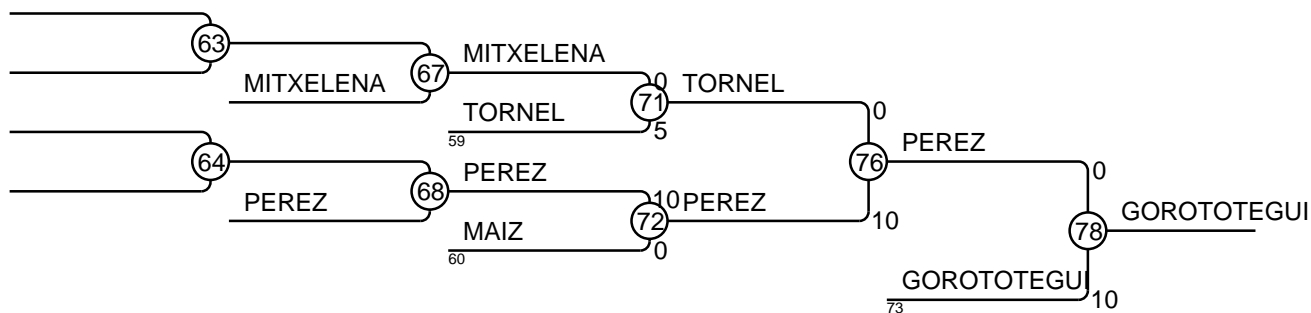
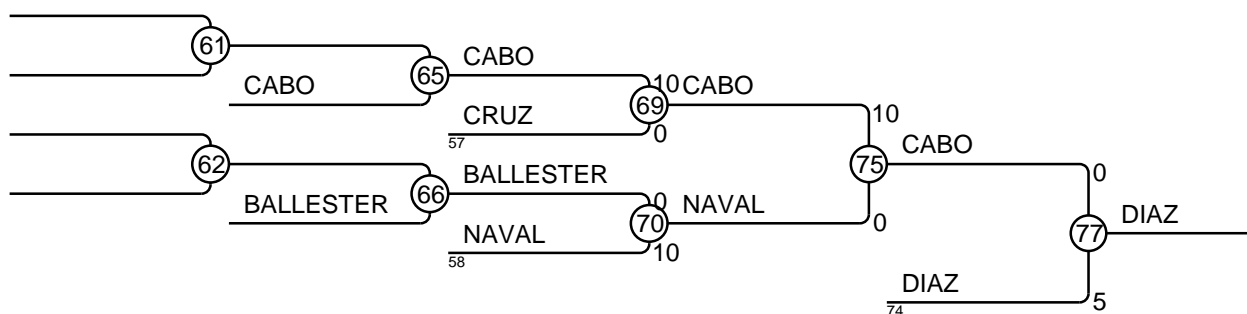

Clasificación

Pos.	Nombre
1	Rubén GARRIGA, Aragón
2	Javier RAMOS, Valencia
3	Mario DIAZ, Madrid
3	Andoni GOROTOTEGUI, País Vasco
5	Jorge CABO, Valencia
5	Eugenio PEREZ, Cantabria
7	Arnau NAVAL, Cataluña
7	Victor TORNEL, Valencia

Copa España Cadete Pamplona

Cad M -60

Competidores: 40

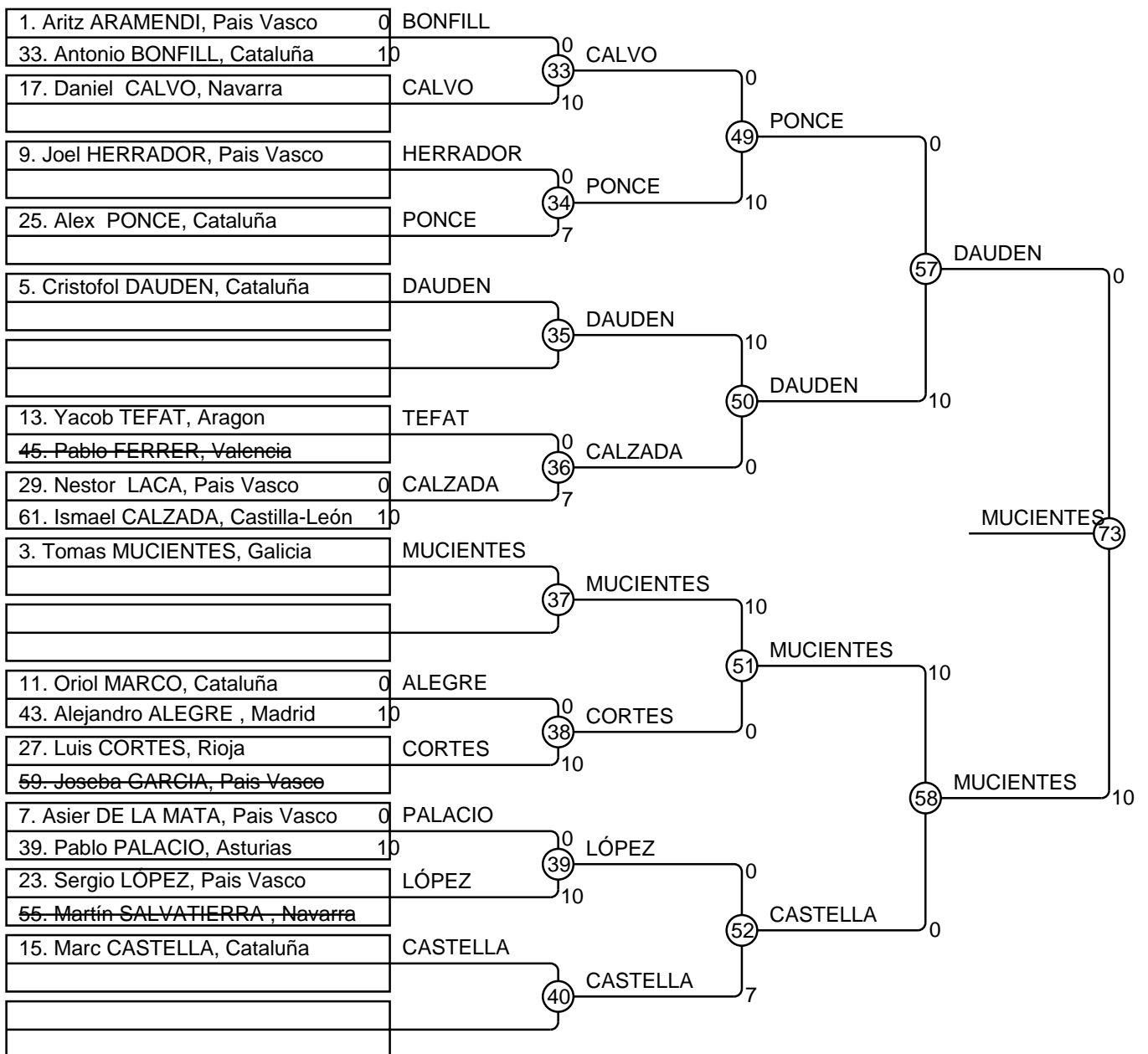

Copa España Cadete Pamplona

Cad M -60

Competidores: 40

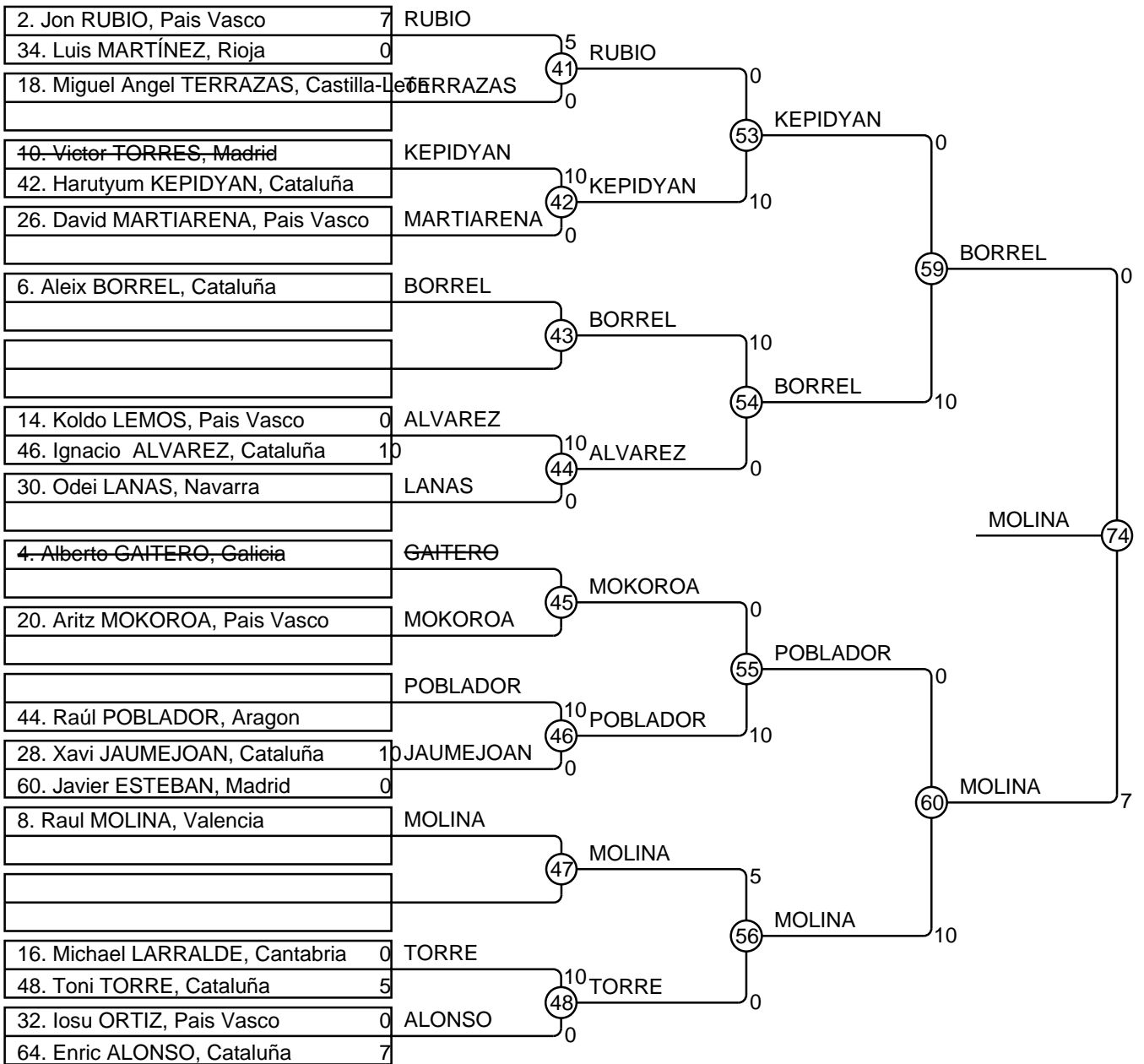

Copa España Cadete Pamplona

Cad M -60

Competidores: 40

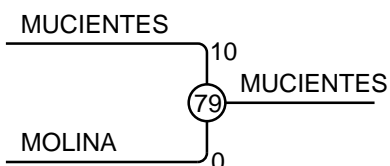
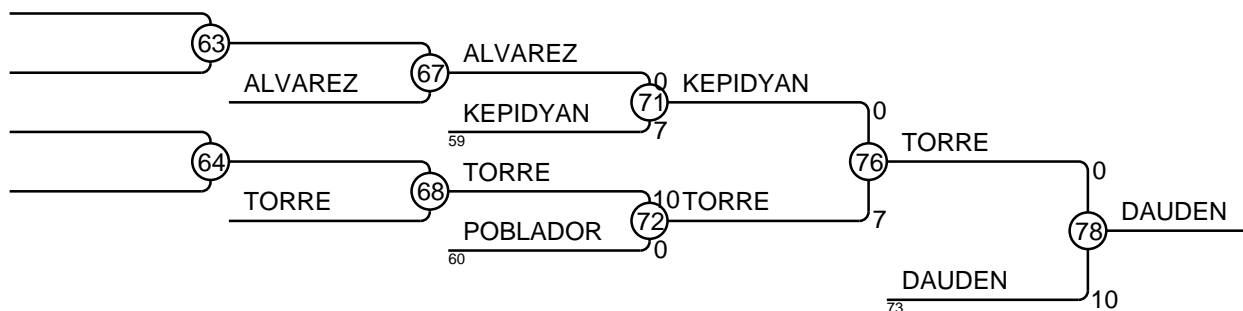
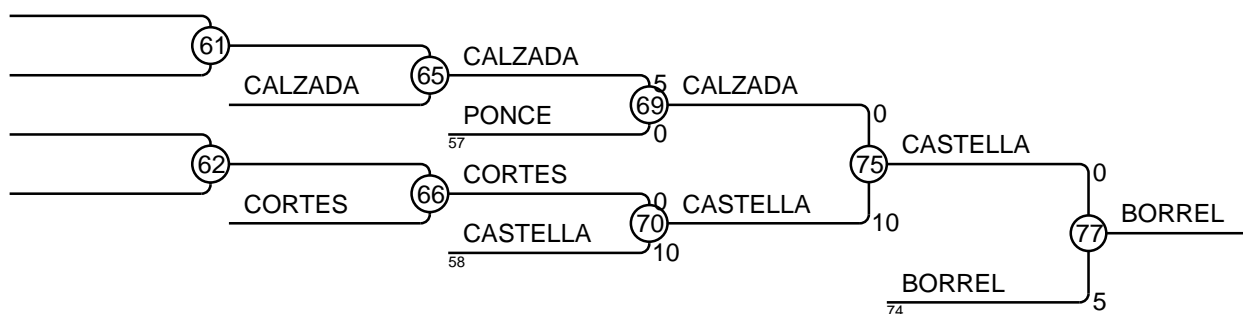

Clasificación

Pos.	Nombre
1	Tomas MUCIENTES, Galicia
2	Raul MOLINA, Valencia
3	Aleix BORREL, Cataluña
3	Cristofol DAUDEN, Cataluña
5	Marc CASTELLA, Cataluña
5	Toni TORRE, Cataluña
7	Ismael CALZADA, Castilla-León
7	Harutyum KEPIDYAN, Cataluña

Copa España Cadete Pamplona

Cad M -66

Competidores: 45

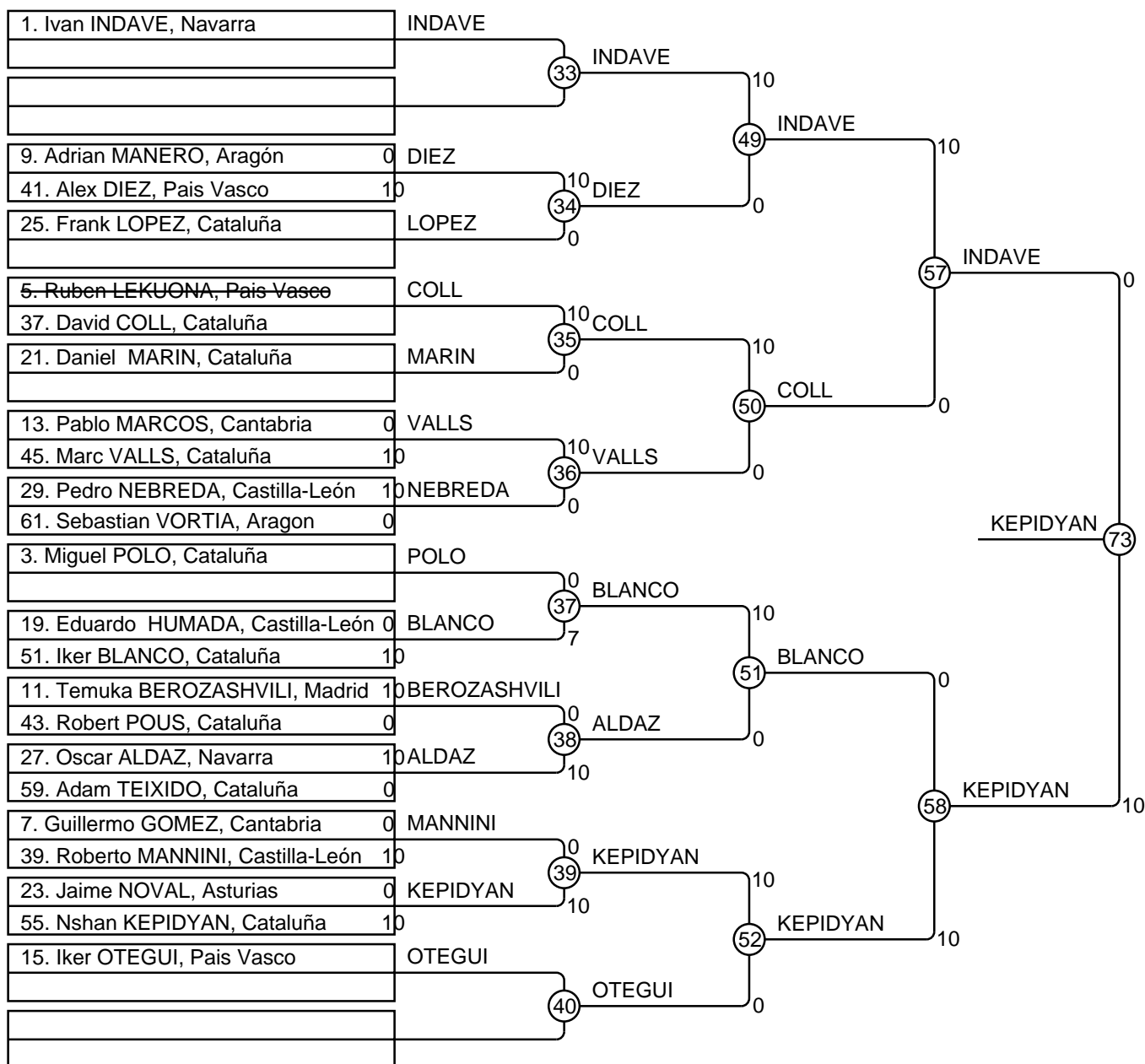

Copa España Cadete Pamplona

Cad M -66

Competidores: 45

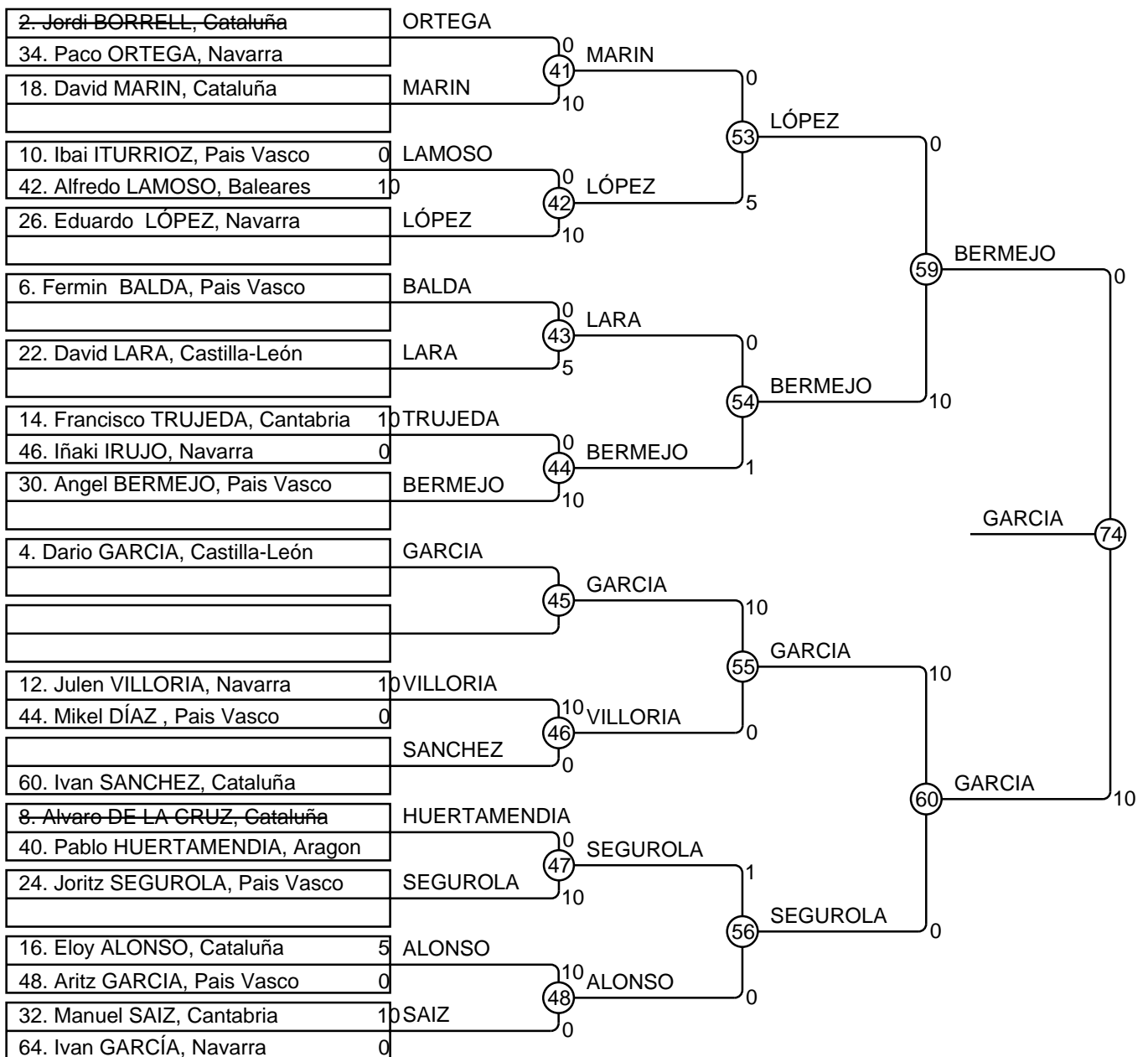

Copa España Cadete Pamplona

Cad M -66

Competidores: 45

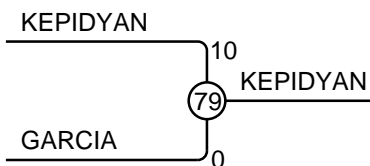
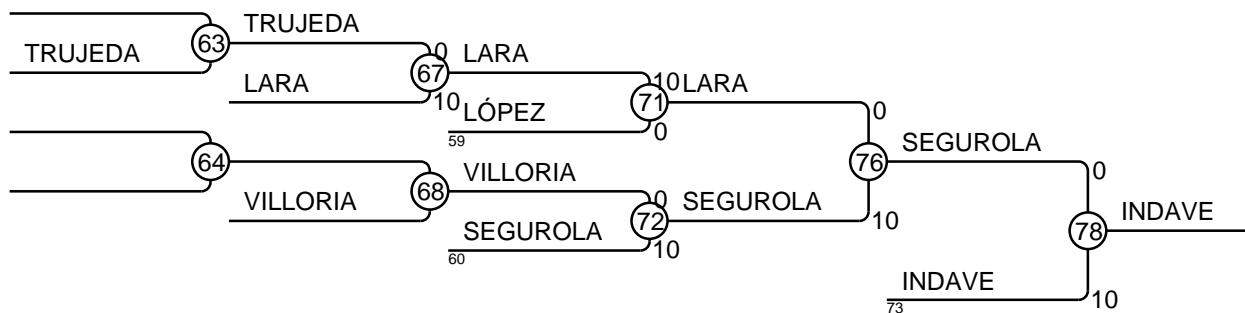
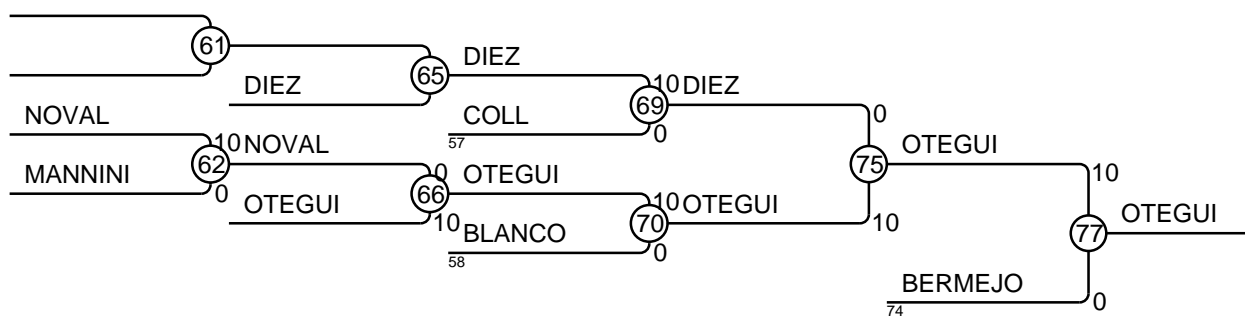

Clasificación

Pos.	Nombre
1	Nshan KEPIDYAN, Cataluña
2	Dario GARCIA, Castilla-León
3	Iker OTEGUI, Pais Vasco
3	Ivan INDAVE, Navarra
5	Angel BERMEJO, Pais Vasco
5	Joritz SEGUROLA, Pais Vasco
7	Alex DIEZ, Pais Vasco
7	David LARA, Castilla-León

Copa España Cadete Pamplona

Cad M -73

Competidores: 33

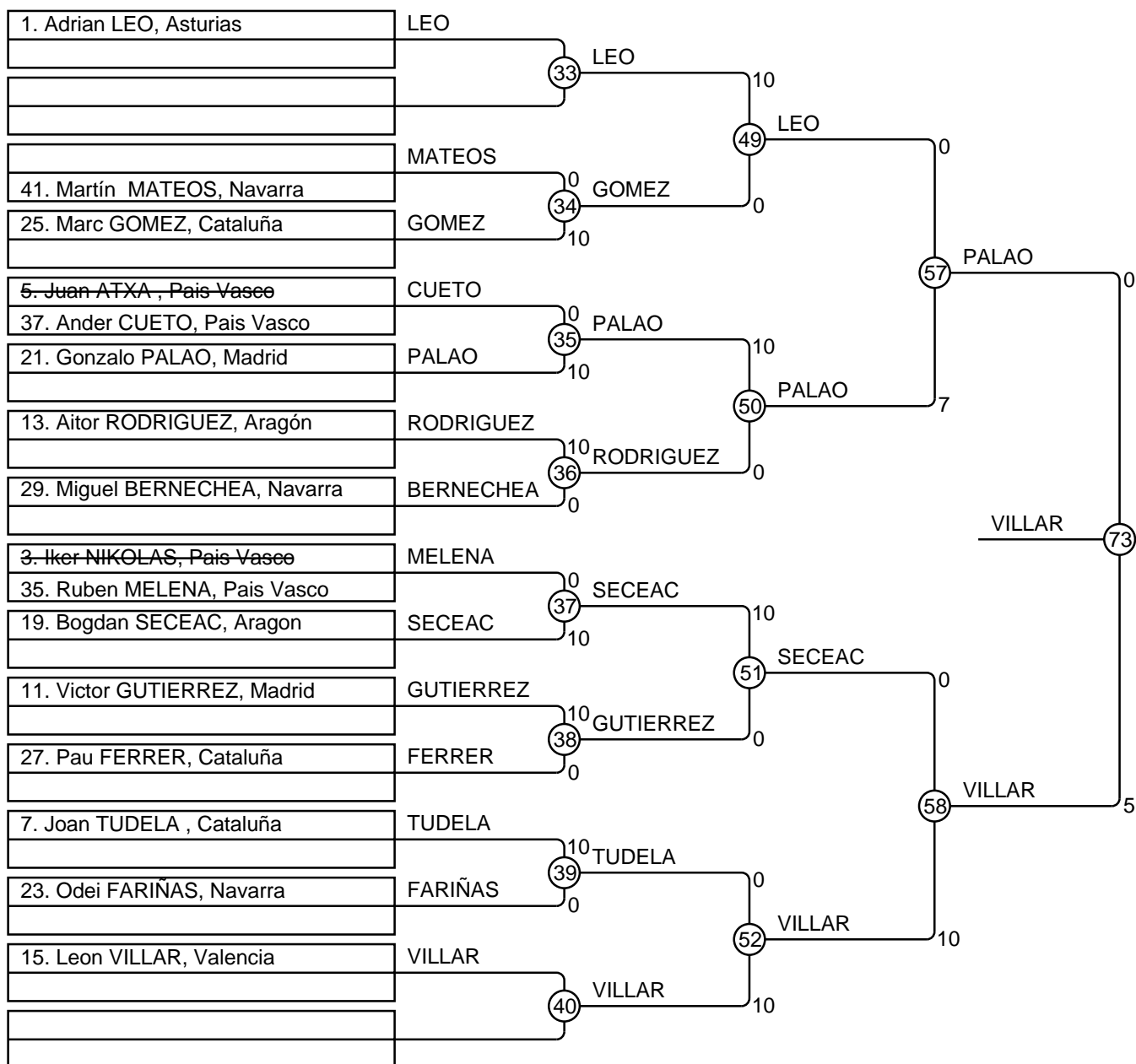

Copa España Cadete Pamplona

Cad M -73

Competidores: 33

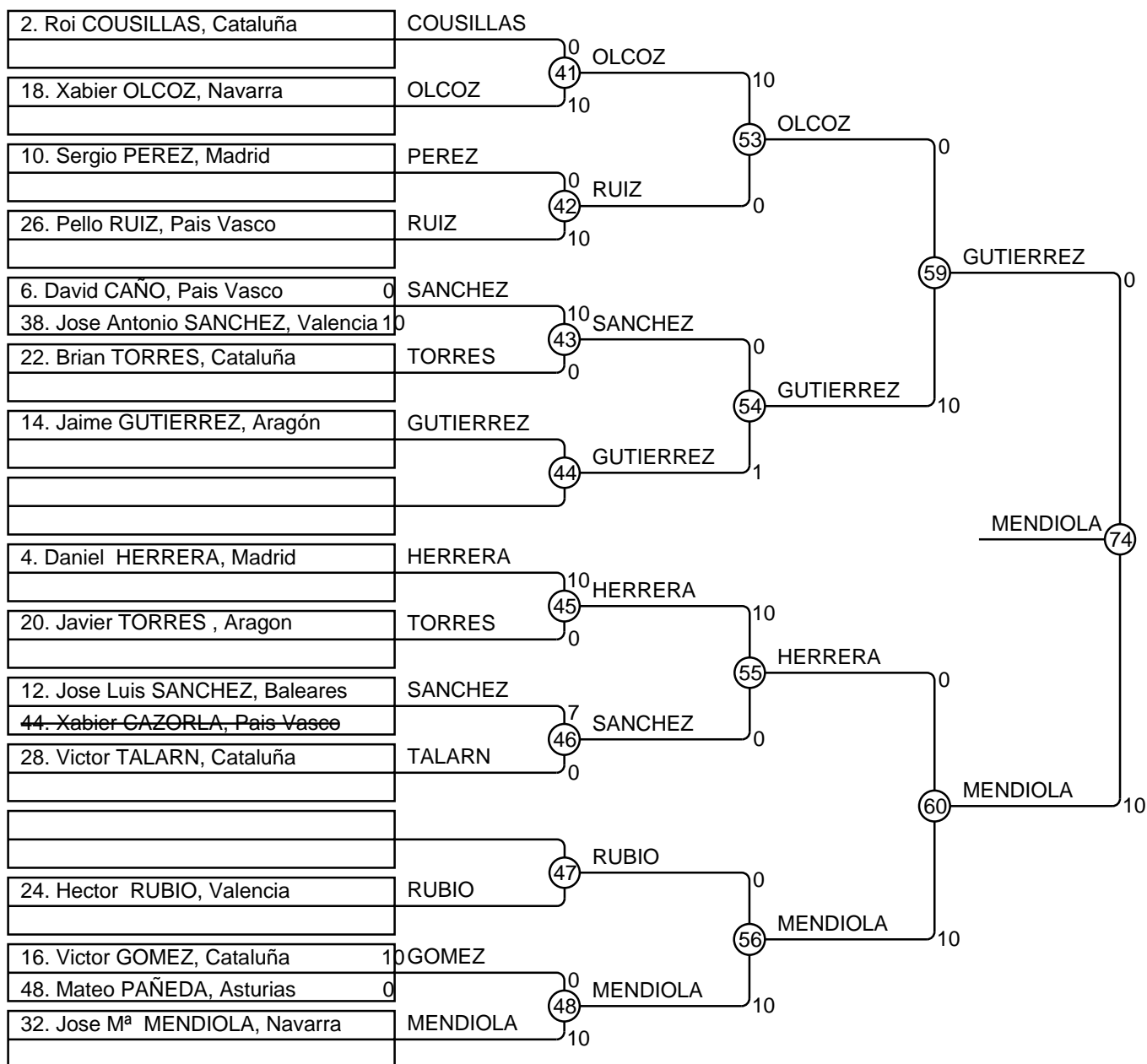

Copa España Cadete Pamplona

Cad M -73

Competidores: 33

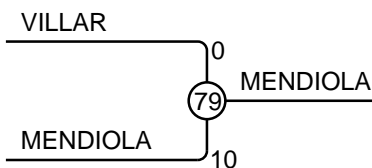
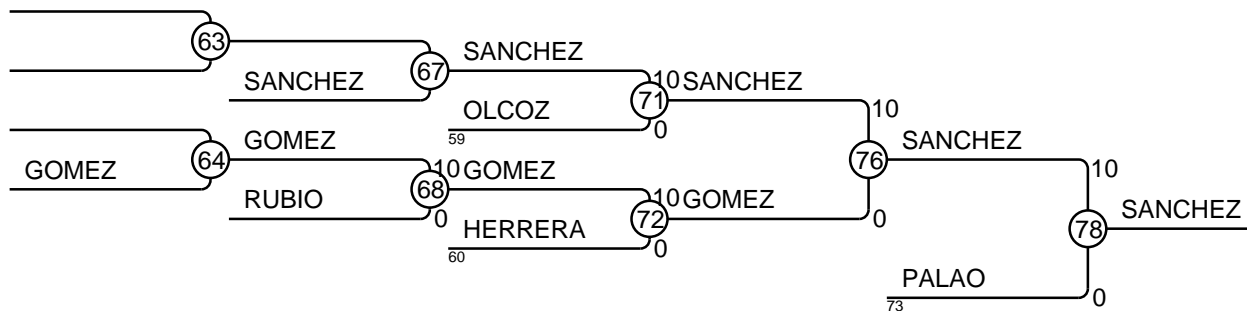
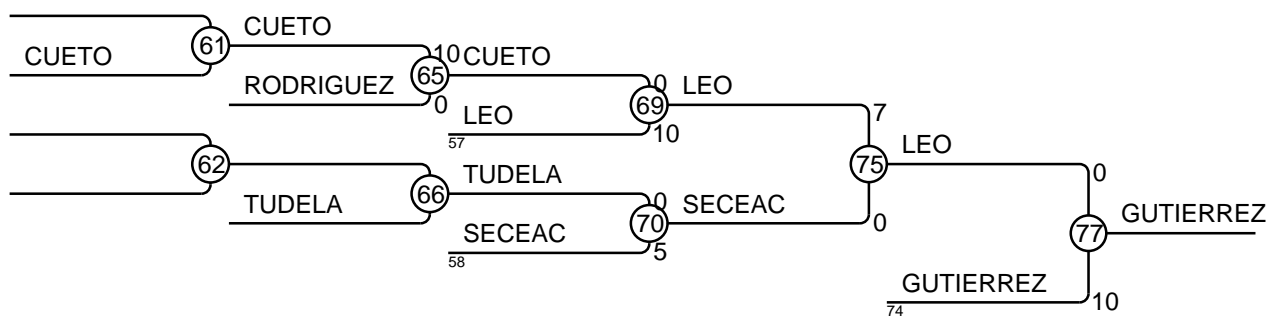

Clasificación

Pos.	Nombre
1	Jose M ^a MENDIOLA, Navarra
2	Leon VILLAR, Valencia
3	Jaime GUTIERREZ, Aragón
3	Jose Antonio SANCHEZ, Valencia
5	Adrian LEO, Asturias
5	Gonzalo PALAO, Madrid
7	Bogdan SECEAC, Aragon
7	Victor GOMEZ, Cataluña

Copa España Cadete Pamplona

Cad M -81

Competidores: 17

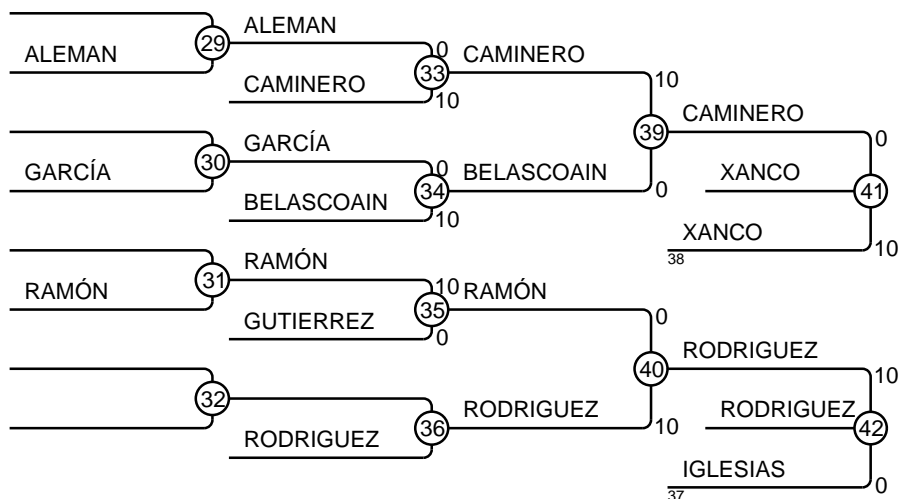
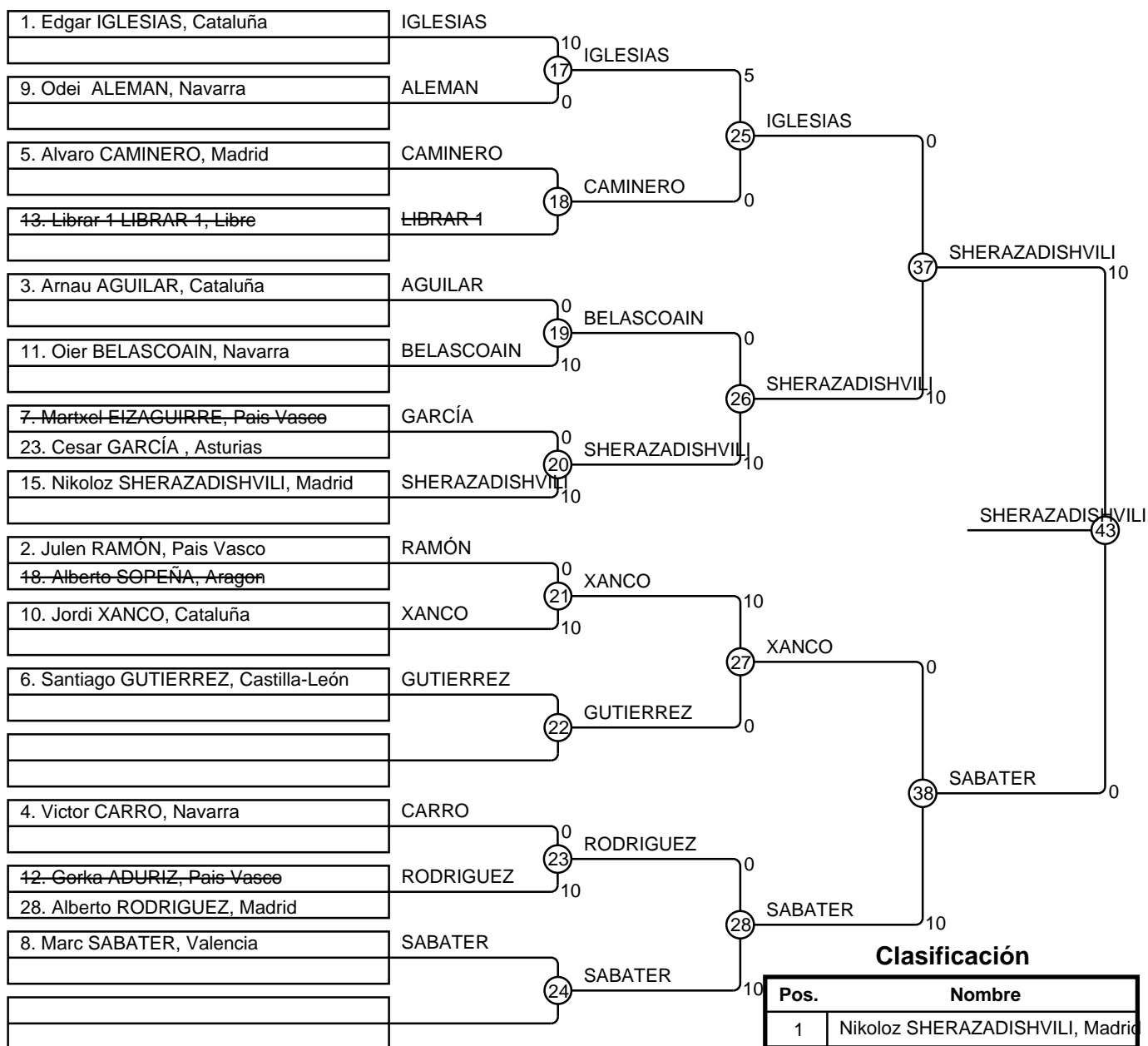

Clasificación

Pos.	Nombre
1	Nikoloz SHERAZADISHVILI, Madrid
2	Marc SABATER, Valencia
3	Jordi XANCO, Cataluña
3	Alberto RODRIGUEZ, Madrid
5	Alvaro CAMINERO, Madrid
5	Edgar IGLESIAS, Cataluña
7	Oier BELASCOAIN, Navarra
7	Julen RAMÓN, Pais Vasco

Copa España Cadete Pamplona

Cad M -90

Competidores: 9

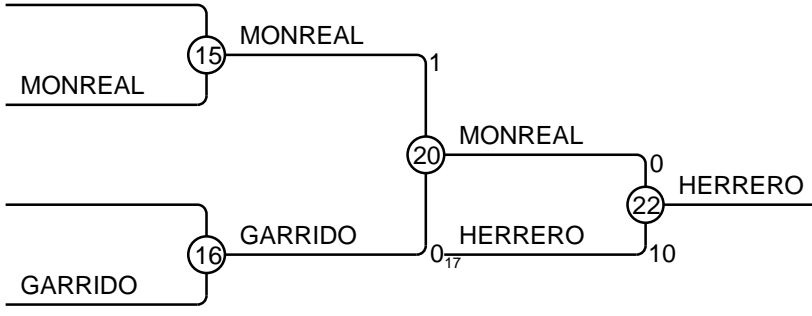
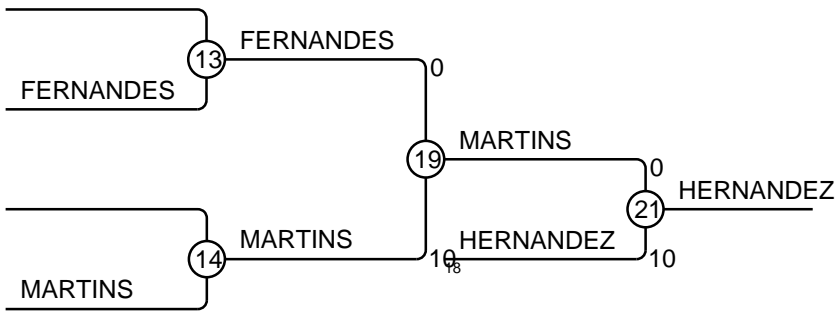
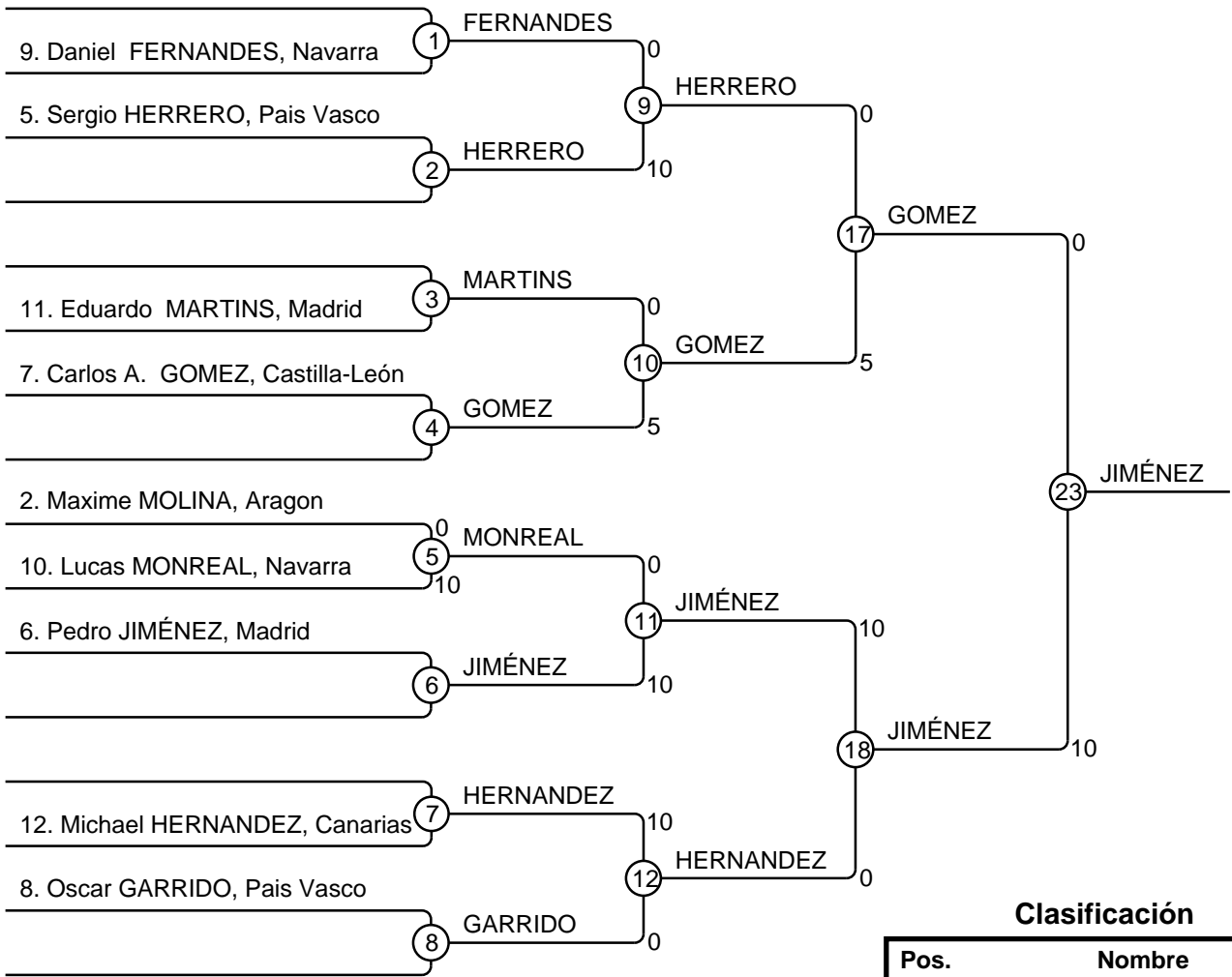

Clasificación

Pos.	Nombre
1	Pedro JIMÉNEZ, Madrid
2	Carlos A. GOMEZ, Castilla-León
3	Michael HERNANDEZ, Canarias
3	Sergio HERRERO, Pais Vasco
5	Eduardo MARTINS, Madrid
5	Lucas MONREAL, Navarra
7	Daniel FERNANDES, Navarra
7	Oscar GARRIDO, Pais Vasco

Copa España Cadete Pamplona

Cad M +90

Competidores: 6

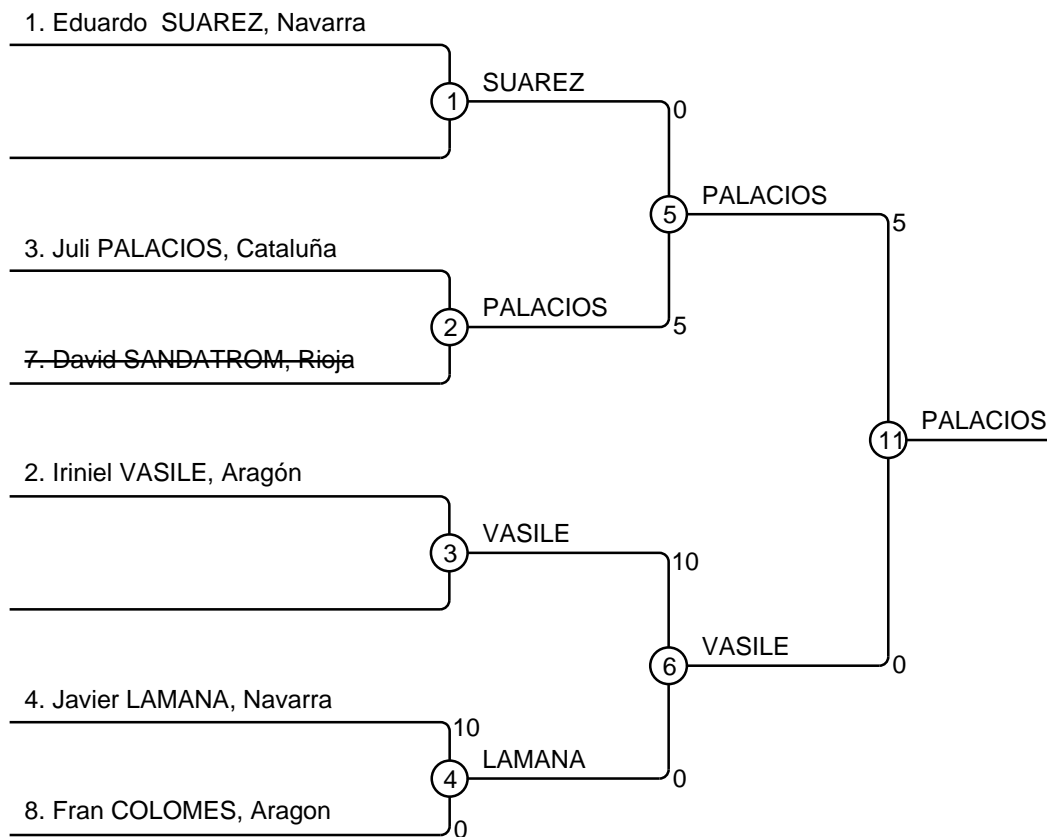

Clasificación

Pos.	Nombre
1	Juli PALACIOS, Cataluña
2	Iriniel VASILE, Aragón
3	Javier LAMANA, Navarra
3	Eduardo SUAREZ, Navarra
5	
5	Fran COLOMES, Aragon
7	
7	

